

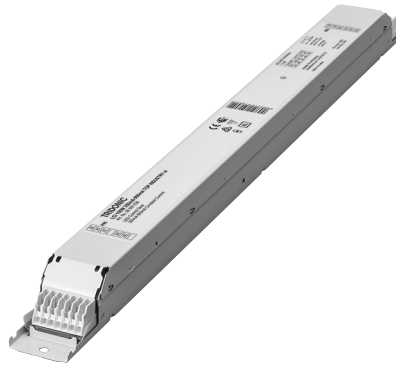

**TALEXdriver LCI 100W 350mA–900mA TOP INDUSTRY sl**  
TOP series

## Product description

- Fixed output constant current built-in LED Driver, particularly suitable for industrial applications in tough environments such as cold warehouses or factories with elevated ambient temperatures
- The LED Driver is designed for a life-time stated above under reference conditions and with a failure probability of less than 10 %
- If being operated up to 50 °C ambient temperature for 100,000 h the LED Driver offers a lower failure probability of less than 2.5 %
- Output current adjustable between 350 – 900 mA
- Max. output power 100 W
- Nominal life-time up to 100,000 h
- 8-year guarantee
- Suitable for mains voltage peaks (burst/surge) up to 4 kV
- Extended temperature range of -40 ... +70 °C



## Properties

- White slim metal casing
- Type of protection IP20

## Functions

- Adjustable output current (I-select resistor)
- Intelligent Temperature Guard (overtemperature protection)
- Short-circuit proof
- Overload protection
- Suitable for emergency escape lighting systems acc. to EN 50172
- Intelligent Voltage Guard (overvoltage indication and undervoltage shutdown)



Standards, page 4

IP20    

### TALEXdriver LCI 100W 350mA–900mA TOP INDUSTRY sl TOP series

#### Technical data

Rated supply voltage	220 – 240 V
Input voltage, AC	198 – 264 V
Input voltage, DC	170 – 280 V
Mains frequency	0 / 50 / 60 Hz
Overtoltage protection	320 V AC, 48 h
Typ. current (at 230 V, 50 Hz, full load) <sup>①</sup>	486 mA
Typ. current (220 V, 0 Hz, full load, 15 % dimming level) <sup>①</sup>	79 mA
Leakage current (PE)	< 0,27 mA
Max. input power	111 W
Typ. efficiency (at 230 V, 50 Hz, full load) <sup>①</sup>	> 90 %
λ (at 230 V, 50 Hz, full load) <sup>①</sup>	0,99
Typ. input current in no-load operation	49 mA
Typ. input power in no-load operation	1,26 W
In-rush current (peak / duration)	40 A / 214 μs
THD (at 230 V, 50 Hz, full load) <sup>①</sup>	< 4 %
Time to light (at 230 V, 50 Hz, full load)	< 0,4 s
Time to light (DC mode)	< 0,4 s
Switchover time (AC/DC)	< 0,4 s
Turn off time (at 230 V, 50 Hz, full load)	< 50 ms
Output current tolerance	± 3 %
Output LF current ripple (< 120 Hz)	< 2 %
Max. peak output current	Output current + 18 %
Max. output voltage (no-load voltage)	250 V
Suitable for burst / surge peaks up to (between L - N)	4 kV
Suitable for burst / surge peaks up to (between L/N - PE)	4 kV
Burst / surge peaks output side against PE	< 0.5 kV
Dimensions L x W x H	425 x 30 x 28 mm

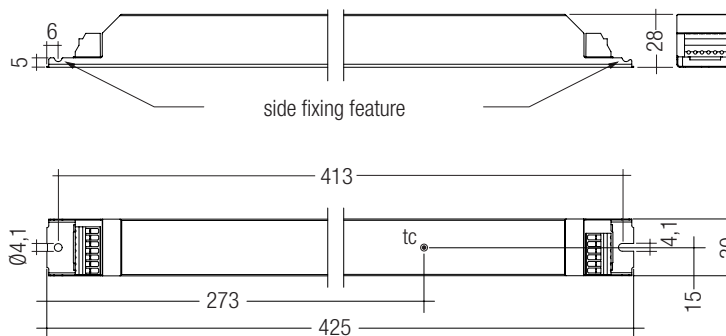

#### Ordering data

Type	Article number	Packaging carton	Packaging pallet	Weight per pc.
LCI 100W 350mA-900mA TOP INDUSTRY sl	28000538	10 pc(s).	480 pc(s).	0.419 kg

#### Specific technical data

Type	Output current	Min. forward voltage	Max. forward voltage <sup>②</sup>	Max. output power <sup>②</sup>	Typ. power consumption (at 230 V, 50 Hz, full load)	Typ. current consumption (at 230 V, 50 Hz, full load)	Max. casing temperature tc	Ambient temperature ta max.	I-select resistor value
	350 mA	99 V	220 V	77 W	85 W	377 mA	95 °C	-40 ... +70 °C	open
	375 mA	99 V	220 V	83 W	92 W	404 mA	95 °C	-40 ... +70 °C	71.50 kΩ
	400 mA	99 V	220 V	88 W	96 W	423 mA	95 °C	-40 ... +70 °C	66.50 kΩ
	425 mA	99 V	220 V	94 W	103 W	451 mA	95 °C	-40 ... +70 °C	61.90 kΩ
	450 mA	99 V	220 V	99 W	109 W	478 mA	100 °C	-40 ... +65 °C	57.60 kΩ
	475 mA	95 V	211 V	100 W	110 W	481 mA	100 °C	-40 ... +65 °C	53.60 kΩ
	500 mA	90 V	200 V	100 W	109 W	479 mA	100 °C	-40 ... +65 °C	49.90 kΩ
	525 mA	86 V	190 V	100 W	110 W	480 mA	100 °C	-40 ... +65 °C	45.30 kΩ
	550 mA	82 V	182 V	100 W	110 W	480 mA	100 °C	-40 ... +65 °C	42.20 kΩ
	575 mA	78 V	174 V	100 W	110 W	480 mA	100 °C	-40 ... +65 °C	38.30 kΩ
	600 mA	75 V	167 V	100 W	110 W	481 mA	100 °C	-40 ... +65 °C	35.70 kΩ
LCI 100W 350mA-900mA TOP INDUSTRY sl	625 mA	72 V	160 V	100 W	110 W	482 mA	100 °C	-40 ... +65 °C	32.40 kΩ
	650 mA	69 V	154 V	100 W	110 W	482 mA	100 °C	-40 ... +65 °C	28.70 kΩ
	675 mA	67 V	148 V	100 W	110 W	482 mA	100 °C	-40 ... +65 °C	26.10 kΩ
	700 mA	64 V	143 V	100 W	110 W	483 mA	100 °C	-40 ... +65 °C	22.00 kΩ
	725 mA	62 V	138 V	100 W	110 W	482 mA	100 °C	-40 ... +65 °C	17.40 kΩ
	750 mA	60 V	133 V	100 W	110 W	482 mA	100 °C	-40 ... +65 °C	15.00 kΩ
	775 mA	58 V	129 V	100 W	110 W	482 mA	100 °C	-40 ... +65 °C	12.40 kΩ
	800 mA	56 V	125 V	100 W	110 W	481 mA	100 °C	-40 ... +65 °C	10.00 kΩ
	825 mA	55 V	121 V	100 W	110 W	484 mA	100 °C	-40 ... +65 °C	7.68 kΩ
	850 mA	53 V	118 V	100 W	110 W	484 mA	100 °C	-40 ... +65 °C	5.36 kΩ
	875 mA	51 V	114 V	100 W	110 W	484 mA	100 °C	-40 ... +65 °C	3.16 kΩ
	900 mA	50 V	111 V	100 W	111 W	486 mA	100 °C	-40 ... +65 °C	short circuit (0 Ω)

<sup>①</sup> Depending on the selected output current.

<sup>②</sup> At full load.

**Product description**

- Ready-for-use resistor to set output current value
- Compatible with LED Driver series TOP and ECO
- Resistor is base isolated
- Resistor power 0.25 W
- Resistor value tolerance  $\pm 1\%$

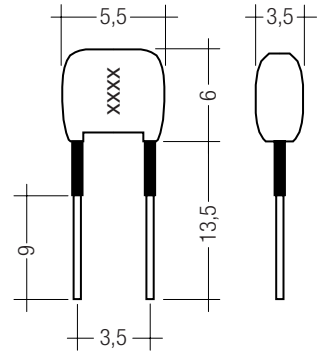
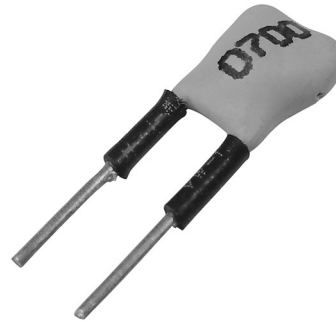

**Ordering data**

Type	Article number	Colour	Marking	Resistor value	Packaging bag	Weight per pc.
I-SELECT PLUG 400mA GN	28000451	Green	0400	66.50 k $\Omega$	10 pc(s).	0.001 kg
I-SELECT PLUG 450mA GN	28000451	Green	0450	57.60 k $\Omega$	10 pc(s).	0.001 kg
I-SELECT PLUG 500mA GN	28000277	Green	0500	49.90 k $\Omega$	10 pc(s).	0.001 kg
I-SELECT PLUG 550mA GN	28000453	Green	0550	42.20 k $\Omega$	10 pc(s).	0.001 kg
I-SELECT PLUG 600mA GN	28000454	Green	0600	35.70 k $\Omega$	10 pc(s).	0.001 kg
I-SELECT PLUG 650mA GN	28000455	Green	0650	28.70 k $\Omega$	10 pc(s).	0.001 kg
I-SELECT PLUG 700mA GN	28000278	Green	0700	22.00 k $\Omega$	10 pc(s).	0.001 kg
I-SELECT PLUG 750mA GN	28000456	Green	0750	15.00 k $\Omega$	10 pc(s).	0.001 kg
I-SELECT PLUG 800mA GN	28000457	Green	0800	10.00 k $\Omega$	10 pc(s).	0.001 kg
I-SELECT PLUG 850mA GN	28000458	Green	0850	5.36 k $\Omega$	10 pc(s).	0.001 kg
I-SELECT PLUG MAX GR	28000274	Grey	MAX	0 $\Omega$	10 pc(s).	0.001 kg

### Standards

EN 55015  
 EN 60068-2-27 (shock – test case: 1,000 shocks in 6 directions with 30 g / 18 ms)  
 EN 60068-2-64 (vibration – test case: acc. to table A.1 transport / category 2)  
 EN 61000-3-2  
 EN 61000-3-3  
 EN 61347-1  
 EN 61347-2-13  
 EN 62384  
 EN 61547  
 According to EN 50172 for use in central battery systems  
 According to EN 60598-2-22 suitable for emergency lighting installations

### Overload protection

If the output voltage range is exceeded the LED Driver turns off the LED output. After restart of the LED Driver the output will be activated again.

### Overtemperature protection

The LED Driver is protected against temporary thermal overheating. If the temperature limit is exceeded the output current of the LED is reduced. The temperature protection is activated approx. +5 °C above  $t_{c\ max}$  (see page 2). On DC operation this function is deactivated to fulfill emergency requirements.

### Short-circuit behaviour

In case of a short circuit at the LED output the LED output is switched off. After restart of the LED Driver the output will be activated again.

### No-load operation

The LED Driver will not be damaged in the no-load operation. The output will be deactivated and therefore free of voltage. If a LED load is connected the device has to be restarted before the output will be activated again.

### DC emergency operation

The LED Driver is designed for operation on DC voltage and pulsed DC voltage.

Light output level in DC operation: 15 %

The voltage-dependent input current of Driver incl. LED module is depending on the used load.

The voltage-dependent no-load current of Driver (without or defect LED module) is for:

AC: 50 mA  
 DC: 6 mA

### Output current setting

Output current can be set by connecting a resistor between the 2 "I sel" terminals. Relationship between output current and resistor value can be found at the table "Specific technical data". Resistor values specified from standardised resistor value ranges.

Resistor value tolerance has to be  $\leq 1\%$ .

Resistor power has to be  $\geq 0.1\ W$ .

If the resistor is connected with wires a max. wire length of 2 m may not be exceeded and possible interferences have to be avoided.

Resistor detection at each start.

Change of the resistor value during the operation will be not considered.

Resistors for the main output current values can be ordered from Tridonic (see accessories).

### Intelligent temperature monitoring (ITM)

The device offers the possibility to connect a silicium based temperature sensor (KTY81-210, KTY82-210) to monitor the LED temperature and protect the module against thermal damages.

If the temperature limit is exceeded the LED output will be dimmed or turned off. If the temperature falls below threshold the device will automatically return to the nominal operation.

The use of a NTC or PTC resistor is not possible.

The device can be operated without a sensor (default setting).

### Conditions of use and storage

Humidity: 5 % up to max. 85 %, not condensed (max. 56 days/year at 85 %)

Storage temperature: -40 °C up to max. +80 °C

The devices have to be within the specified temperature range ( $t_a$ ) before they can be operated.

### Expected life-time

Type	Output current	$t_a$	40 °C	50 °C	55 °C	60 °C	65 °C	70 °C
LCI 100W 350mA-900mA TOP INDUSTRY sl	< 450 mA	$t_c$	65 °C	75 °C	80 °C	85 °C	90 °C	95 °C
		Life-time	>100,000 h	>100,000 h	>100,000 h	100,000 h	74,000 h	52,000 h
	450 – 900 mA	$t_c$	75 °C	85 °C	90 °C	95 °C	100 °C	x
		Life-time	>100,000 h	>100,000 h	>100,000 h	79,000 h	64,000 h	x

The LED Driver is designed for a life-time stated above under reference conditions and with a failure probability of less than 10 %.

### Maximum loading of automatic circuit breakers

Automatic circuit breaker type	C10	C13	C16	C20	B10	B13	B16	B20	Inrush current
Installation $\emptyset$	1.5 mm <sup>2</sup>	1.5 mm <sup>2</sup>	2.5 mm <sup>2</sup>	2.5 mm <sup>2</sup>	1.5 mm <sup>2</sup>	1.5 mm <sup>2</sup>	2.5 mm <sup>2</sup>	2.5 mm <sup>2</sup>	$I_{max}$ time
LCI 100W 350mA-900mA TOP INDUSTRY sl	10	14	16	22	5	7	8	11	44 A 250 $\mu$ s

### Harmonic distortion in the mains supply (at 230 V / 50 Hz and full load) in %

	THD	3.	5.	7.	9.	11.
LCI 100W 350mA-900mA TOP INDUSTRY sl	4	3.5	< 1	< 1	< 1	< 1

## Electrical connections

### Wiring

LED module/LED Driver/supply

### IDC interface

- solid wire with a cross section of 0.5 mm<sup>2</sup>

### Horizontal interface

- solid wire with a cross section of 0.5–0.75 mm<sup>2</sup> with an insulation diameter up to 2.5 mm
- strip 8–9 mm of insulation from the cables to ensure perfect operation of the push terminals
- Loosen wire through twisting and pulling

wire preparation:  
0.5 – 0.75 mm<sup>2</sup>

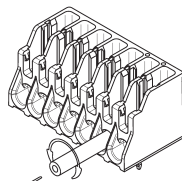
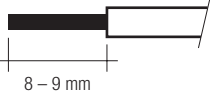

Loosen wire through  
twisting and pulling

### Wiring guidelines

- The cables should be run separately from the mains connections and mains cables to ensure good EMC conditions.
- The LED wiring should be kept as short as possible to ensure good EMC. The max. secondary cable length is 2 m (4 m circuit), this applies for LED output as well as for I-select.
- Secondary switching is not permitted.
- The LED Driver has no inverse-polarity protection on the secondary side. Wrong polarity can damage LED modules with no inverse-polarity protection.

### Earth connection

The earth connection is conducted as protection earth (PE). The LED Driver can be earthed via earth terminal or metal housing. If the LED Driver will be earthed, protection earth (PE) has to be used. There is no earth connection required for the functionality of the LED Driver.

Earth connection is recommended to improve following behaviour.

- Electromagnetic interferences (EMI)
- Transmission of mains transients to the LED output

In general it is recommended to earth the LED Driver if the LED module is mounted on earthed luminaire parts respectively heat sinks and thereby representing a high capacity against earth.

## Circuit diagram

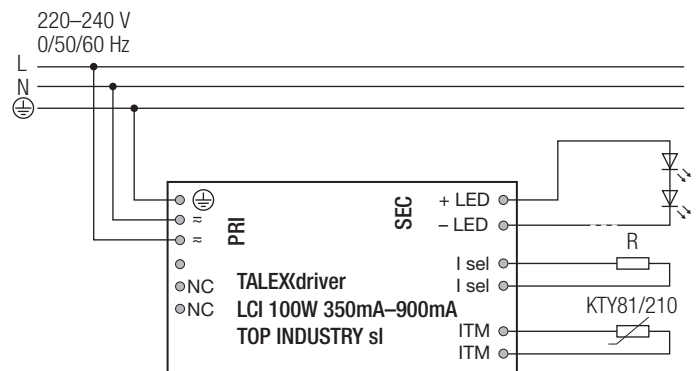

### Isolation and electric strength testing of luminaires

Electronic devices can be damaged by high voltage. This has to be considered during the routine testing of the luminaires in production.

According to IEC 60598-1 Annex Q (informative only!) or ENEC 303-Annex A, each luminaire should be submitted to an isolation test with 500 V<sub>DC</sub> for 1 second. This test voltage should be connected between the interconnected phase and neutral terminals and the earth terminal.

The isolation resistance must be at least 2 MΩ.

As an alternative, IEC 60598-1 Annex Q describes a test of the electrical strength with 1500 V<sub>AC</sub> (or 1.414 x 1500 V<sub>DC</sub>). To avoid damage to the electronic devices this test must not be conducted.

### Additional information

Additional technical information at [www.tridonic.com](http://www.tridonic.com) → Technical Data

Guarantee conditions at [www.tridonic.com](http://www.tridonic.com) → Services

Life-time declarations are informative and represent no warranty claim. No warranty if device was opened.

Diagrams LCI 100W 350mA-900mA TOP INDUSTRY

Efficiency vs load

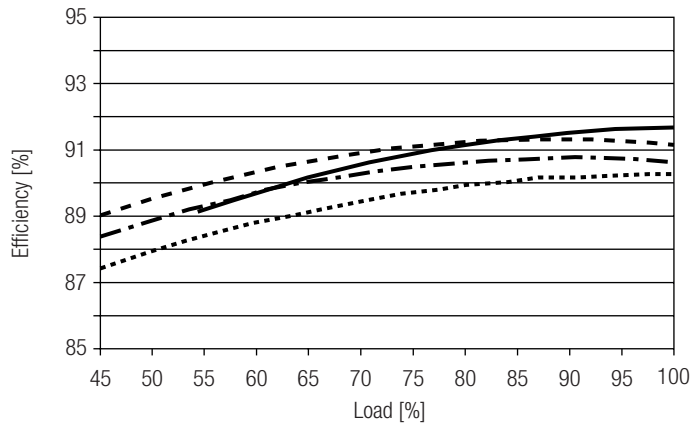

Power factor vs load

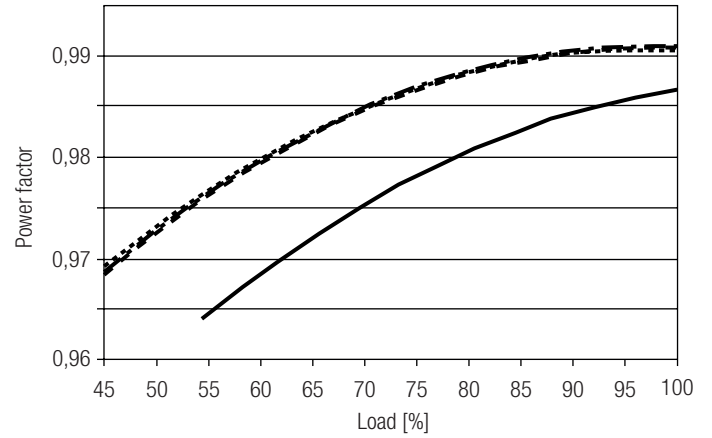

Input power vs load

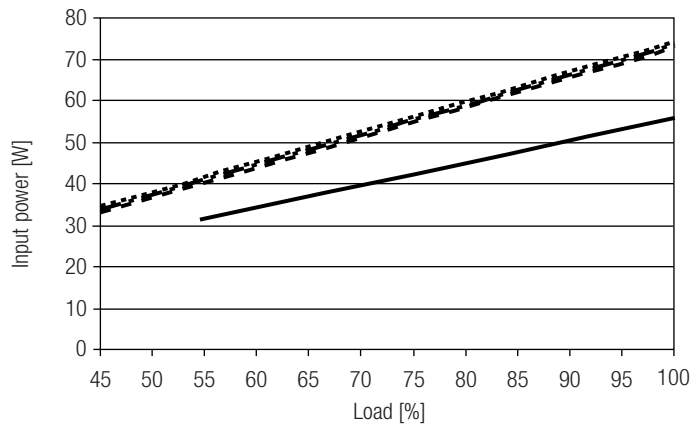

Input current vs load

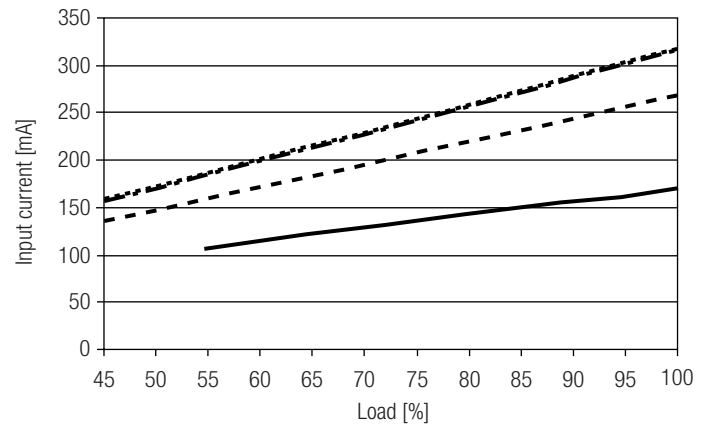

THD vs load

