

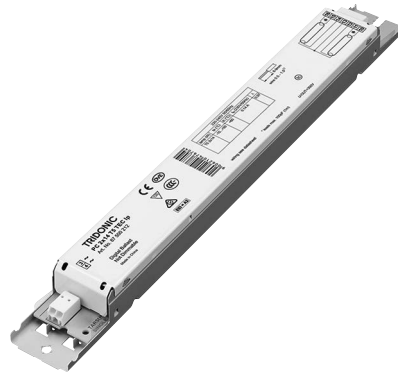

### PC T5 TEC Ip, 14 – 28 W PC TEC T5

#### Product description

- CELMA Energy Efficiency Index A2
- Nominal life-time up to 30,000 h (at ta 50 °C with a failure rate max. 0.3 % per 1,000 h)
- Large temperature range (for values see table)
- Lamp preheating for min. 30,000 starts without replacement of lamps (15,000 for 1x14 W application)
- Automatic start after replacement of defective lamps
- Safety shutdown of defective lamps and at end of lamp life
- Temperature protection as per EN 61347-2-3 C5e



#### Technical data

Mains voltage range	220 – 240 V
AC voltage range	198 – 264 V
Mains frequency	50 / 60 Hz
Overvoltage protection	320 V AC, 1 h
Time to light	≤ 2 s
Operating frequency	≥ 40 kHz
Type of protection	IP 20

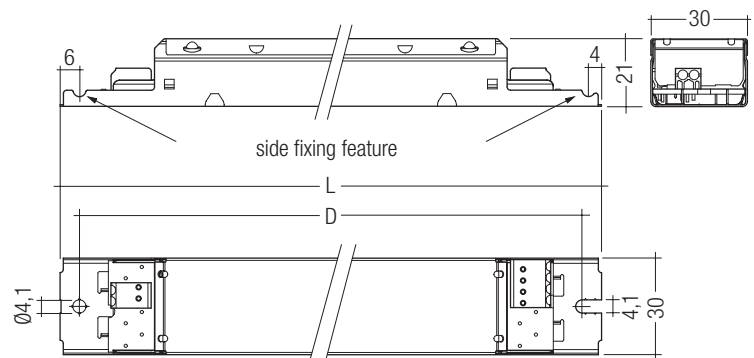

Standards, page 2

Wiring diagrams and installation examples, page 5

#### Ordering data

Type	Article number	Packaging carton	Packaging, low volume	Packaging, high volume	Weight per pc.
<b>For luminaires with 1 lamp</b>					
PC 1x14 T5 TEC Ip	87500211	50 pc(s).	1,050 pc(s).	3,150 pc(s).	0.112 kg
PC 1x21 T5 TEC Ip	87500217	50 pc(s).	1,050 pc(s).	3,150 pc(s).	0.121 kg
PC 1x28 T5 TEC Ip	87500215	50 pc(s).	1,050 pc(s).	3,150 pc(s).	0.121 kg
<b>For luminaires with 2 lamps</b>					
PC 2x14 T5 TEC Ip	87500212	50 pc(s).	900 pc(s).	2,700 pc(s).	0.155 kg
PC 2x28 T5 TEC Ip	87500216	50 pc(s).	900 pc(s).	2,700 pc(s).	0.176 kg
<b>For luminaires with 3 lamps</b>					
PC 3x14 T5 TEC Ip	87500213	50 pc(s).	900 pc(s).	2,700 pc(s).	0.164 kg
<b>For luminaires with 4 lamps</b>					
PC 4x14 T5 TEC Ip	87500214	50 pc(s).	900 pc(s).	2,700 pc(s).	0.176 kg

#### Specific technical data

Lamp wattage	Lamp type	Type	Article number	Dimensions LxWxH	Hole spacing D	Lamp power	Circuit power	EEI	Current at 50 Hz		λ at 50 Hz		tc point max.	Temperature range ta	tc / ta for ≥ 30,000 h
									220 V	240 V	220 V	240 V			
<b>For luminaires with 1 lamp</b>															
1 x 14 W	T5	PC 1x14 T5 TEC Ip	87500211	230 x 30 x 21 mm	220 mm	13.7 W	16.5 W	A2	0.07 A	0.07 A	0.95	0.95	60 °C	-10 ... 50 °C	60 / 50 °C
1 x 21 W	T5	PC 1x21 T5 TEC Ip	87500217	230 x 30 x 21 mm	220 mm	20.7 W	23.5 W	A2	0.11 A	0.11 A	0.96	0.96	60 °C	-10 ... 50 °C	60 / 50 °C
1 x 28 W	T5	PC 1x28 T5 TEC Ip	87500215	230 x 30 x 21 mm	220 mm	27.8 W	31.5 W	A2	0.14 A	0.14 A	0.97	0.97	65 °C	-10 ... 50 °C	65 / 50 °C
<b>For luminaires with 2 lamps</b>															
2 x 14 W	T5	PC 2x14 T5 TEC Ip	87500212	280 x 30 x 21 mm	270 mm	27.4 W	31.0 W	A2	0.14 A	0.14 A	0.97	0.97	60 °C	-10 ... 50 °C	60 / 50 °C
2 x 28 W	T5	PC 2x28 T5 TEC Ip	87500216	280 x 30 x 21 mm	270 mm	55.6 W	61.5 W	A2	0.26 A	0.26 A	0.98	0.98	70 °C	-10 ... 50 °C	70 / 50 °C
<b>For luminaires with 3 lamps</b>															
3 x 14 W	T5	PC 3x14 T5 TEC Ip	87500213	280 x 30 x 21 mm	270 mm	41.1 W	46.0 W	A2	0.21 A	0.21 A	0.97	0.97	65 °C	-10 ... 50 °C	65 / 50 °C
<b>For luminaires with 4 lamps</b>															
4 x 14 W	T5	PC 4x14 T5 TEC Ip	87500214	280 x 30 x 21 mm	270 mm	54.8 W	61.0 W	A2	0.27 A	0.27 A	0.98	0.98	70 °C	-10 ... 50 °C	70 / 50 °C

**Standards**

EN 55015  
EN 61000-3-2  
EN 61000-3-3  
EN 61347-1  
EN 61347-2-3  
EN 61547

**AC operation**

Mains voltage:  
220 – 240 V 50 / 60 Hz  
176 – 264 V 50 / 60 Hz including safety  
tolerance (+10 % / –20 %)

Below 198 V<sub>ac</sub> for sustained periods  
of time with reduced ballast life.

**Ambient Temperature**

0 °C to +50 °C

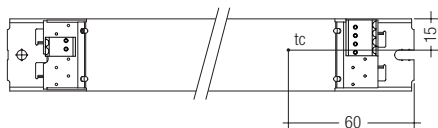

PC 1x14 T5 TEC Ip  
PC 1x21 T5 TEC Ip  
PC 1x28 T5 TEC Ip

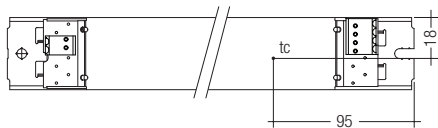

PC 3x14 T5 TEC Ip  
PC 4x14 T5 TEC Ip

**Harmonic distortion in the mains supply**

Type	Lamp type	Wattage	THD at 230 V / 50 Hz
PC 1x14 T5 TEC Ip	T5	1x14 W	< 20 %
PC 1x21 T5 TEC Ip	T5	1x21 W	< 20 %
PC 1x28 T5 TEC Ip	T5	1x28 W	< 20 %
PC 2x14 T5 TEC Ip	T5	2x14 W	< 15 %
PC 2x28 T5 TEC Ip	T5	2x28 W	< 15 %
PC 3x14 T5 TEC Ip	T5	3x14 W	< 15 %
PC 4x14 T5 TEC Ip	T5	4x14 W	< 15 %

**Working voltage**

Type	Lamp type	Wattage	U <sub>out</sub>
PC 1x14 T5 TEC Ip	T5	1x14 W	250 V
PC 1x21 T5 TEC Ip	T5	1x21 W	300 V
PC 1x28 T5 TEC Ip	T5	1x28 W	300 V
PC 2x14 T5 TEC Ip	T5	2x14 W	300 V
PC 2x28 T5 TEC Ip	T5	2x28 W	430 V
PC 3x14 T5 TEC Ip	T5	3x14 W	350 V
PC 4x14 T5 TEC Ip	T5	4x14 W	430 V

**Ballast lumen factor (EN 60929 8.1)**

Type	Lamp type	Wattage	AC-BLF at U = 230 V, 25 °C
PC 1x14 T5 TEC Ip	T5	1x14 W	1,00 (± 10 %)
PC 1x21 T5 TEC Ip	T5	1x21 W	1,00 (± 10 %)
PC 1x28 T5 TEC Ip	T5	1x28 W	1,00 (± 10 %)
PC 2x14 T5 TEC Ip	T5	2x14 W	1,00 (± 10 %)
PC 2x28 T5 TEC Ip	T5	2x28 W	1,00 (± 10 %)
PC 3x14 T5 TEC Ip	T5	3x14 W	1,00 (± 10 %)
PC 4x14 T5 TEC Ip	T5	4x14 W	1,00 (± 10 %)

All data are typical values

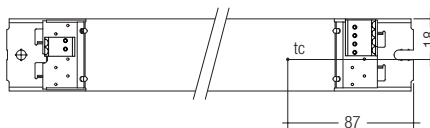

PC 2x14 T5 TEC Ip  
PC 2x28 T5 TEC Ip

The tc point is related to the ballast life duration.

PC T5 TEC Ip is designed for an average life-time of 30,000 hours under reference conditions and with a failure rate of less than 0.3% for every 1,000 hours of operation.

Reduced temperature will extend ballast life-time.

Humidity: 5 % up to max. 85 %,  
not condensed  
(max. 56 days/year at 85 %)

Storage temperature: -40 °C up to max. +80 °C

The devices have to be within the specified temperature range (ta) before they can be operated.

#### Expected life-time

Type	Lamp type	Lamp power	ta	40 °C	50 °C	60 °C
PC 1x14 T5 TEC lp	T5	1x14 W	tc	50 °C	60 °C	x
			Life-time	50,000 h	30,000 h	x
PC 1x21 T5 TEC lp	T5	1x21 W	tc	50 °C	60 °C	x
			Life-time	50,000 h	30,000 h	x
PC 1x28 T5 TEC lp	T5	1x28 W	tc	55 °C	65 °C	x
			Life-time	50,000 h	30,000 h	x
PC 2x14 T5 TEC lp	T5	2x14 W	tc	50 °C	60 °C	x
			Life-time	50,000 h	30,000 h	x
PC 2x28 T5 TEC lp	T5	2x28 W	tc	60 °C	70 °C	x
			Life-time	50,000 h	30,000 h	x
PC 3x14 T5 TEC lp	T5	3x14 W	tc	55 °C	65 °C	x
			Life-time	50,000 h	30,000 h	x
PC 4x14 T5 TEC lp	T5	4x14 W	tc	60 °C	70 °C	x
			Life-time	50,000 h	30,000 h	x

x = not permitted

#### Maximum loading of automatic circuit breakers

Automatic circuit	C10	C13	C16	C20	B10	B13	B16	B20	Inrush current
Installation Ø	1.5 mm <sup>2</sup>	1.5 mm <sup>2</sup>	1.5 mm <sup>2</sup>	2.5 mm <sup>2</sup>	1.5 mm <sup>2</sup>	1.5 mm <sup>2</sup>	1.5 mm <sup>2</sup>	2.5 mm <sup>2</sup>	I <sub>max</sub> Pulse
PC 1x14 T5 TEC lp	60	80	100	120	30	40	50	60	14.0 A 64 µs
PC 1x21 T5 TEC lp	50	70	80	100	25	35	40	50	18.0 A 88 µs
PC 1x28 T5 TEC lp	50	70	80	100	25	35	40	50	18.0 A 88 µs
PC 2x14 T5 TEC lp	50	70	80	100	25	35	40	50	17.3 A 91 µs
PC 2x28 T5 TEC lp	30	39	49	60	15	20	25	30	15.6 A 211 µs
PC 3x14 T5 TEC lp	30	40	50	60	15	20	25	30	22.0 A 110 µs
PC 4x14 T5 TEC lp	30	39	49	60	15	20	25	30	17.6 A 179 µs

#### Wiring advice

The lead length is dependant on the capacitance of the cable.  
Earthing is not required for the device to operate.  
Connection to earth reduces radio interference.

With standard solid wire 0.5/0.75 mm<sup>2</sup> the capacitance of the lead is approx. 80 pF/m. This value is influenced by the way the wiring is made.  
In borderline cases the capacitance must be measured inside the luminaire.  
Keep lamp wires short. Lamp connection with twin ballast should be made with symmetrical wiring.  
Hot leads and cold leads should be separated as much as possible.

Ballast	Terminals	Maximum capacitance allowed	
		Cold	Hot
PC 1xx T5 TEC lp	13, 14	15, 16	200 pF 100 pF
PC 2xx T5 TEC lp	12, 13, 14	10, 11, 15, 16	200 pF 100 pF
PC 3xx T5 TEC lp	9, 10, 12, 14	7, 8, 11, 13, 15, 16	200 pF 100 pF
PC 4xx T5 TEC lp	9, 10, 11, 12, 13, 14	7, 8, 15, 16	200 pF 100 pF

To avoid the damage of the control gear, the wiring must be protected against short circuits to earth (sharp edged metal parts, metal cable clips, louver, etc.)

## Installation instructions

### Wiring type and cross section

Solid wire with a cross section of 0.5–1.5 mm<sup>2</sup>. Strip 8–9 mm of insulation from the cables to ensure perfect operation of terminals.

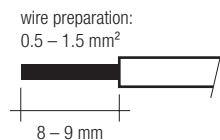

### Release of the wiring

Loosen wire through twisting and pulling or using a Ø 1 mm release tool.

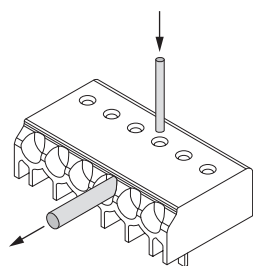

## RFI

Tridonic ballasts are RFI protected in accordance with CISPR 15. To operate the luminaire correctly and to minimise RFI we recommend the following instructions:

- Connection to the lamps of the “hot leads” must be kept as short as possible (marked with \*)
- Mains leads should be kept apart from lamp leads (ideally 5–10 cm distance)
- Do not run mains leads adjacent to the electronic ballast
- Twist the lamp leads
- Keep the distance of lamp leads from the metal work as large as possible
- Connect functional earth over the terminal
- Mains wiring to be twisted when through wiring
- Keep the mains leads inside the luminaire as short as possible

## Side fixing feature

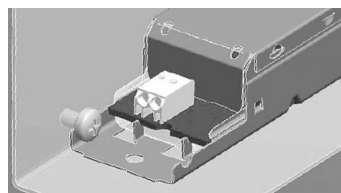

Screw M4, screw head diameter 8–10 mm

## Defective lamp

If a lamp is defective, the ballast switches off and goes into standby. There is an automatic restart once the lamp has been changed.

## T5 lamp information

	14 W	549 mm
	21 W	849 mm
	28 W	1149 mm

## Isolation and electric strength testing of luminaires

Electronic devices can be damaged by high voltage. This has to be considered during the routine testing of the luminaires in production.

According to IEC 60598-1 Annex Q (informative only!) or ENEC 303-Annex A, each luminaire should be submitted to an isolation test with 500 V<sub>DC</sub> for 1 second. This test voltage should be connected between the interconnected phase and neutral terminals and the earth terminal.

The isolation resistance must be at least 2 MΩ.

As an alternative, IEC 60598-1 Annex Q describes a test of the electrical strength with 1500 V<sub>AC</sub> (or 1.414 x 1500 V<sub>DC</sub>). To avoid damage to the electronic devices this test must not be conducted.

## Additional information

Additional technical information at  
[www.tridonic.com](http://www.tridonic.com) → Technical Data

Guarantee conditions at  
[www.tridonic.com](http://www.tridonic.com) → Services

No warranty if device was opened.

Wiring diagrams

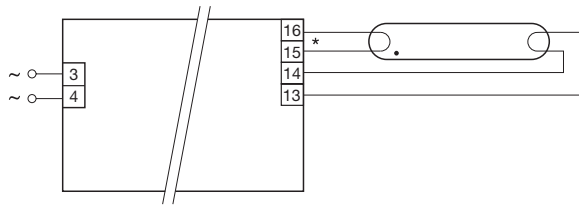

\* leads 15, 16 max. 1.0 m (< 100 pF)  
leads 13, 14 max. 2.0 m (< 200 pF)  
For luminaires of protection class I: Earthing of ground terminal required (according to IEC 60598)  
For luminaires of protection class II: No earthing required

PC 1x14 T5 TEC Ip,  
PC 1x21 T5 TEC Ip,  
PC 1x28 T5 TEC Ip

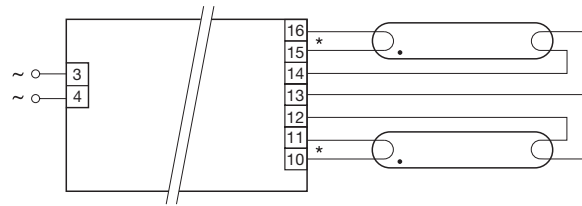

\* leads 10, 11, 15, 16 max. 1.0 m (< 100 pF)  
leads 12, 13, 14 max. 2.0 m (< 200 pF)  
For luminaires of protection class I: Earthing of ground terminal required (according to IEC 60598)  
For luminaires of protection class II: No earthing required

PC 2x14 T5 TEC Ip,  
PC 2x28 T5 TEC Ip

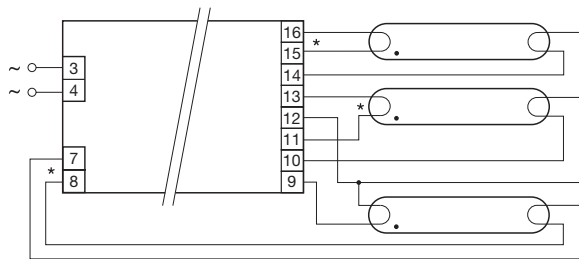

\* leads 7, 8, 11, 13, 15, 16 max. 1.0 m (< 100 pF)  
leads 9, 10, 12, 14 max. 2.0 m (< 200 pF)  
For luminaires of protection class I: Earthing of ground terminal required (according to IEC 60598)  
For luminaires of protection class II: No earthing required

PC 3x14 T5 TEC Ip

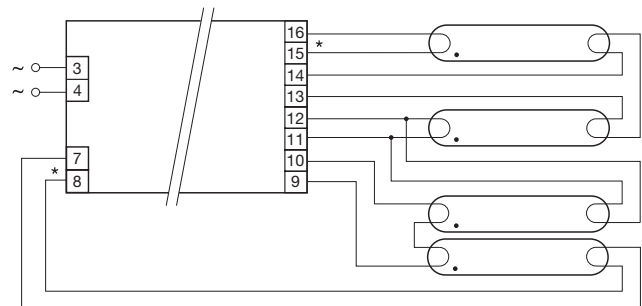

\* leads 7, 8, 15, 16 max. 1.0 m (< 100 pF)  
leads 9, 10, 11, 12, 13, 14 max. 2.0 m (< 200 pF)  
For luminaires of protection class I: Earthing of ground terminal required (according to IEC 60598)  
For luminaires of protection class II: No earthing required

PC 4x14 T5 TEC Ip