



TALEXdriver LCI 150 W 350/500/700/1050 mA OTD EC TEC Outdoor series

Product description

- Independent fixed output LED Driver
- Constant current LED Driver
- Output current 350, 500, 700 or 1,050 mA
- Max. output power 150 W
- Nominal life of 50,000 h (at ta max. 55 °C with a failure rate of max. 0.2 % per 1,000 h)
- For luminaires of protection class I and protection class II
- Temperature protection as per EN 61347-2-13 C5e

Properties

- Robust aluminium casing
- Type of protection IP67

Functions

- Overtemperature protection
- Overload protection
- Short-circuit protection
- No-load protection
- Burst protection voltage up to 1.2 kV
- Surge protection voltage up to 4 kV (L to N)
- Surge protection voltage up to 6 kV (L/N to earth)



Standards, page 3

Wiring diagrams and installation examples, page 4

IP67       

TALEXdriver LCI 150 W 350/500/700/1050 mA OTD EC
TEC Outdoor series

Technical data

Rated supply voltage	220 – 240 V
AC voltage range	198 – 264 V
Current at 50 Hz 230 V	0.79 A
Mains frequency	50 / 60 Hz
Leakage current (at 230 V, 50 Hz, full load)	< 500 µA
Max. input power	165 W
Max. input power for 1,050 mA	174 W
Output power range	75 – 150 W
THD (at 230 V, 50 Hz, full load)	< 10 %
THD (at 230 V, 50 Hz, min. load)	< 10 %
Output current tolerance	± 5 %
Typ. current ripple (at 230 V, 50 Hz, full load)	± 5 %
Turn on time (at 230 V, 50 Hz, full load)	≤ 0.4 s
Turn off time (at 230 V, 50 Hz, full load)	≤ 0.1 s
Hold on time at power failure (output)	0 s
Ambient temperature ta	-40 ... +55 °C
Ambient temperature ta (at life-time 50,000 h)	55 °C
Max. casing temperature tc	85 °C
Storage temperature ts	-40 ... +80 °C
Dimensions L x W x H	236.6 x 60 x 34 mm

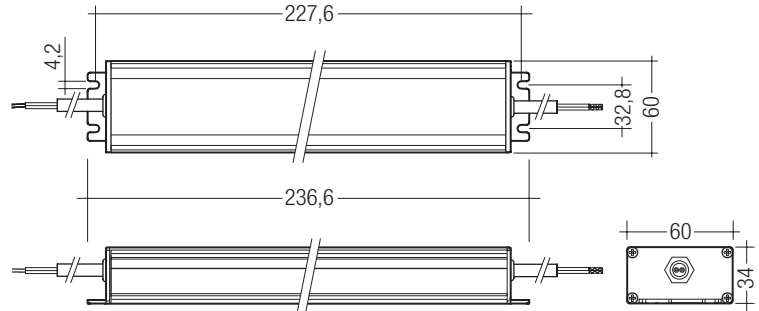

Ordering data

Type	Article number	Packaging, carton	Packaging, low volume	Packaging, high volume	Weight per pc.
LCI 150W 350mA OTD EC	87500334	10 pc(s).	60 pc(s).	400 pc(s).	0.835 kg
LCI 150W 500mA OTD EC	87500335	10 pc(s).	60 pc(s).	400 pc(s).	0.835 kg
LCI 150W 700mA OTD EC	87500336	10 pc(s).	60 pc(s).	400 pc(s).	0.942 kg
LCI 150W 1050mA OTD EC	28000653	10 pc(s).	60 pc(s).	400 pc(s).	0.920 kg

Specific technical data

Type	Output current	Power factor at full load [§]	Efficiency at full load [§]	Power factor at min. load [§]	Efficiency at min. load [§]	Min. forward voltage [§]	Max. forward voltage [§]	Max. output voltage	Max. peak output current [§]
LCI 150W 350mA OTD EC	350 mA	0.99	91 %	0.95	91 %	214 V	429 V	500 V	390 mA
LCI 150W 500mA OTD EC	500 mA	0.99	91 %	0.95	90 %	150 V	300 V	360 V	550 mA
LCI 150W 700mA OTD EC	700 mA	0.99	91 %	0.95	90 %	107 V	214 V	250 V	770 mA
LCI 150W 1050mA OTD EC	1,050 mA	0.99	90 %	0.95	89 %	71 V	143 V	172 V	1,110 mA

[§] Test result at 230 V, 50 Hz.

Standards

EN 55015
 EN 61000-3-2
 EN 61000-3-3
 EN 61347-1
 EN 61347-2-13
 EN 61547

Overload protection

If the forward voltage of the LED module exceeds the maximum output voltage, the LED Driver will enter constant voltage mode. After elimination of the overload the nominal operation is restored automatically.

Overtemperature protection

The LED Driver is protected against temporary thermal overheating. If the temperature limit is exceeded, the unit shuts down itself and then turns on when it cools down. After the elimination of over temperature fault, the nominal operation is restored automatically. The temperature protection is activated typically at 6 °C above t_c max.

Short-circuit behaviour

In case of a short circuit on the secondary side (LED) the LED Driver will latch-up. The LED Driver will recover itself when the short-circuit fault is removed and the AC is recycled (turn off the AC for longer than 0.5 s and then turn on).

No-load operation

The LED Driver works in constant voltage mode. In no-load operation the output voltage will not exceed the specified max. output voltage (no-load voltage, refer to page 1).

Expected life-time

Type	t_a	40 °C	50 °C	55 °C
LCI 150W 350mA OTD EC	t_c	65 °C	75 °C	85 °C
	Life-time	80,000 h	60,000 h	50,000 h
LCI 150W 500mA OTD EC	t_c	65 °C	75 °C	85 °C
	Life-time	80,000 h	60,000 h	50,000 h
LCI 150W 700mA OTD EC	t_c	65 °C	75 °C	85 °C
	Life-time	80,000 h	60,000 h	50,000 h
LCI 150W 1050mA OTD EC	t_c	65 °C	75 °C	85 °C
	Life-time	80,000 h	60,000 h	50,000 h

Maximum loading of automatic circuit breakers

Automatic circuit breaker type	C10	C13	C16	C20	B10	B13	B16	B20	Inrush current
Installation \emptyset	1.5 mm ²	1.5 mm ²	1.5 mm ²	2.5 mm ²	1.5 mm ²	1.5 mm ²	1.5 mm ²	2.5 mm ²	I_{max} Time
LCI 150W 350mA OTD EC	6	10	12	14	3	5	6	7	70 A 250 μ s
LCI 150W 500mA OTD EC	6	10	12	14	3	5	6	7	70 A 250 μ s
LCI 150W 700mA OTD EC	6	10	12	14	3	5	6	7	70 A 250 μ s
LCI 150W 1050mA OTD EC	6	10	12	14	3	5	6	7	70 A 250 μ s

Harmonic distortion in the mains supply (at 230V/50Hz and full load) in %

	THD	3.	5.	7.	9.	11.
LCI 150W 350mA OTD EC	10	4	2	2	2	2
LCI 150W 500mA OTD EC	10	4	2	2	2	2
LCI 150W 700mA OTD EC	10	5	4	4	4	3
LCI 150W 1050mA OTD EC	10	4	2	2	2	2

Fixing conditions

Acidfree, oilfree, fatfree. It is not allowed to exceed the maximum ambient temperature (t_a) stated on the device. Minimum distances stated below are recommendations and depend on the actual luminaire. Is not suitable for fixing in corner. Terminals according to EN 60998-2-1 or EN 60998-2-2 are required.

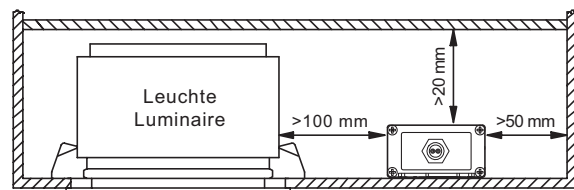
**Storage conditions**

Storage temperature: -40 °C up to max. +80 °C

The devices have to be within the specified temperature range (t_a) before they can be operated.

Wiring diagram

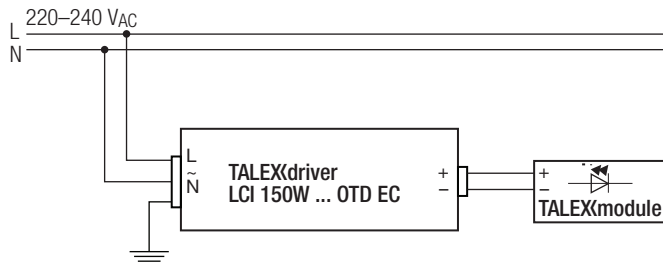

Installation instructions

The switching of LEDs on secondary side is not permitted.

The LED module and all contact points within the wiring must be sufficiently insulated against 2.9 kV surge voltage.

Air and creepage distance must be maintained.

Earth connection

The earth connection is conducted as protection earth (PE). The LED Driver can be earthed via metal housing. If the LED Driver will be earthed, protection earth (PE) has to be used. There is no earth connection required for the functionality of the LED Driver. Earth connection is recommended to improve following behaviour.

- Electromagnetic interferences (EMI)
- LED glowing at stand-by
- Transmission of mains transients to the LED output

In general it is recommended to earth the LED Driver if the LED module is mounted on earthed luminaire parts respectively heat sinks and thereby representing a high capacity against earth.

For Class I application, protection earth need to connected with the metal housing (bottom part).

For Class II application, protection earth is no need to be connected, below 2 scenarios should be considered:

- If the LED Driver housing is screwed on a metal part inside the luminaires, both LED Driver and LED module must be isolated.
- If the LED Driver housing is screwed on a plastic part inside the luminaires, the LED module need to be isolated.

Isolation and electric strength testing of luminaires

Electronic devices can be damaged by high voltage. This has to be considered during the routine testing of the luminaires in production.

According to IEC 60598-1 Annex Q (informative only!) or ENEC 303-Annex A, each luminaire should be submitted to an isolation test with 500 V_{DC} for 1 second. This test voltage should be connected between the interconnected phase and neutral terminals and the earth terminal.

The isolation resistance must be at least 2 MΩ.

As an alternative, IEC 60598-1 Annex Q describes a test of the electrical strength with 1500 V_{AC} (or 1.414 x 1500 V_{DC}). To avoid damage to the electronic devices this test must not be conducted.

Connection

Primary cable			Secondary cable	
L	N	PE	+	-
brown	blue	green/yellow	brown	blue

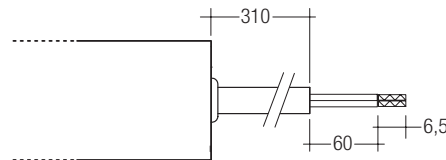

PRI:

3x 1.0 mm²

SEC:

2x 1.0 mm²

Wiring instructions

- All connections must be kept as short as possible to ensure good EMI behaviour
- Mains leads should be kept apart from LED Driver and other leads (ideally 5 – 10 cm distance)
- The maximum length of output wires is 3 m.
- Secondary switching is not permitted.
- Incorrect wiring can damage LED modules.
- The wiring must be protected against short circuits to earth (sharp edged metals parts, metal cable clips, louver, etc.)

Additional information

Additional technical information at www.tridonic.com → Technical Data

Guarantee conditions at www.tridonic.com → Services

Life-time declarations are informative and represent no warranty claim. No warranty if device was opened.

Diagrams LCI 150W 350mA OTD EC

Efficiency vs Load

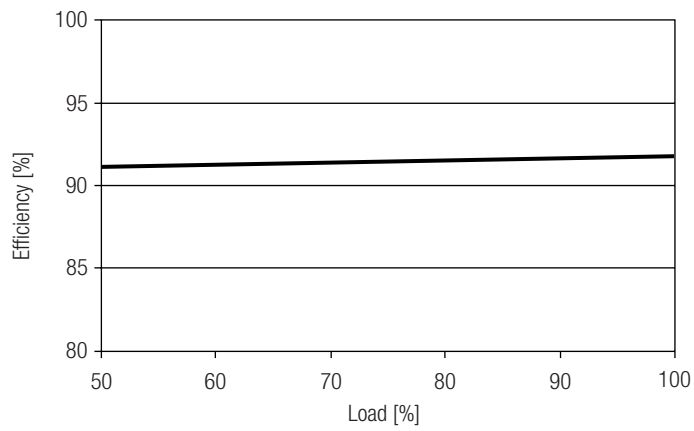

Power factor vs Load

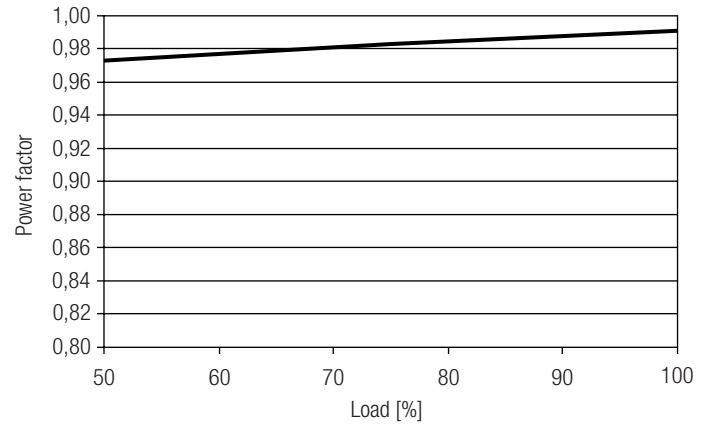

THD vs Load

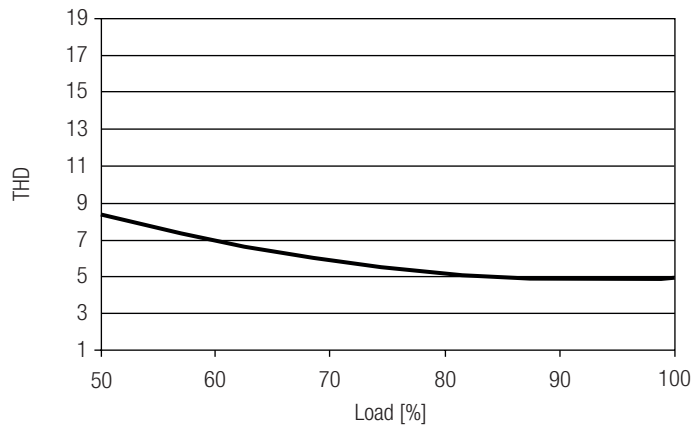

Input current vs load

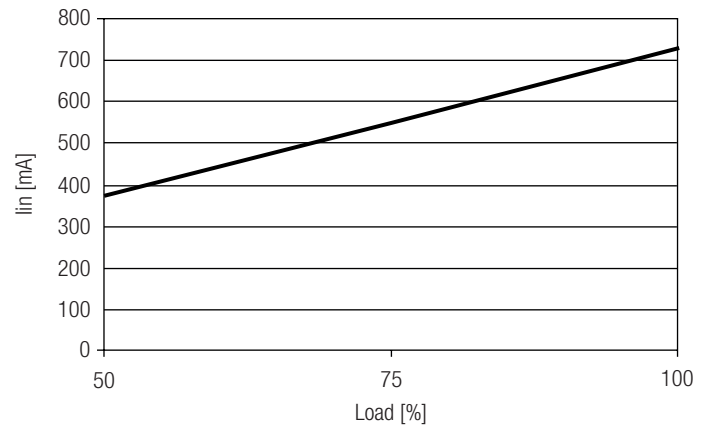

Input power vs load

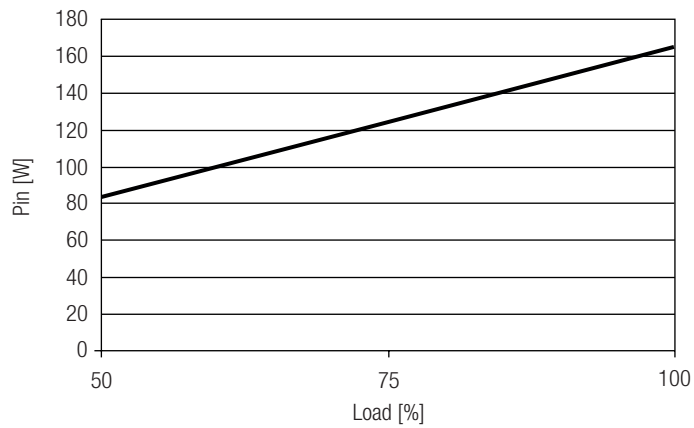

Diagrams LCI 150W 500mA OTD EC

Efficiency vs Load

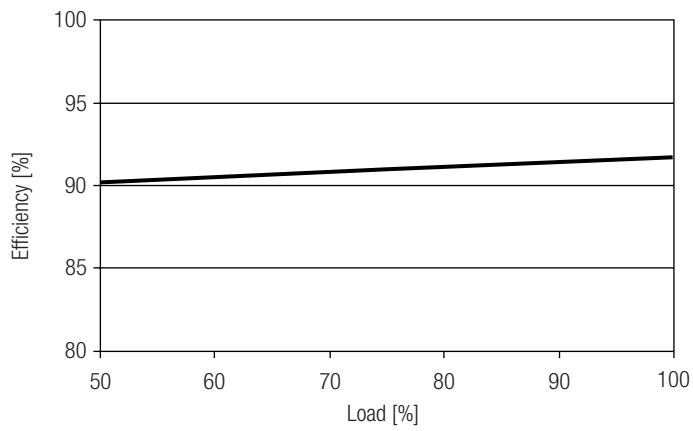

Power factor vs Load

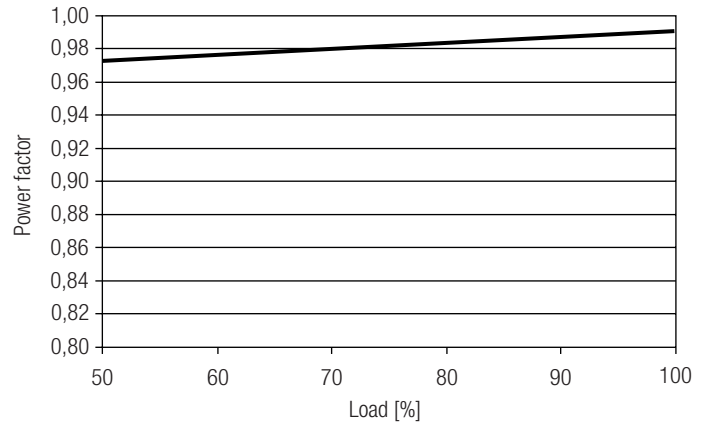

THD vs Load

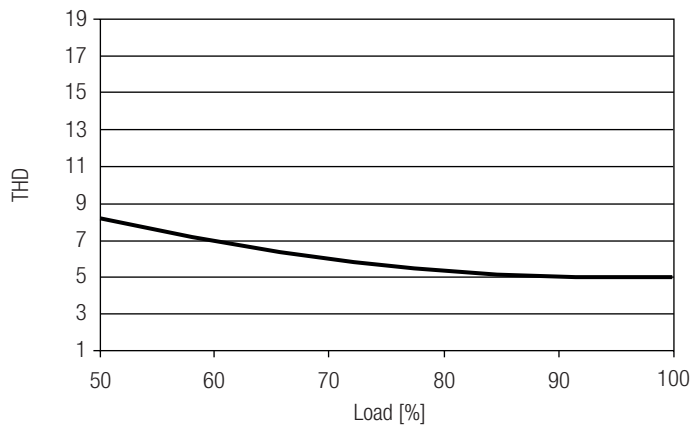

Input current vs load

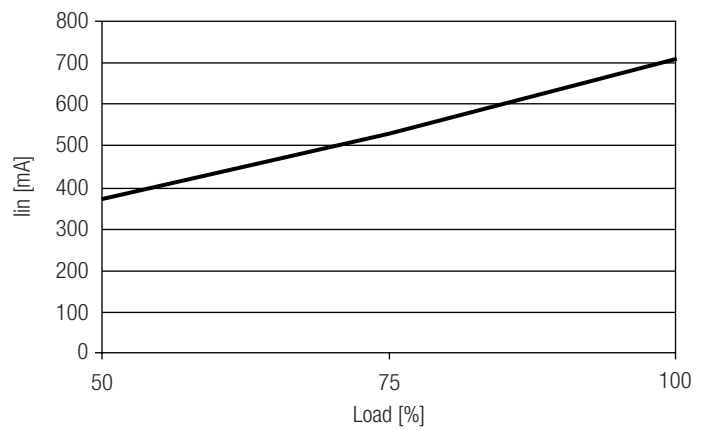

Input power vs load

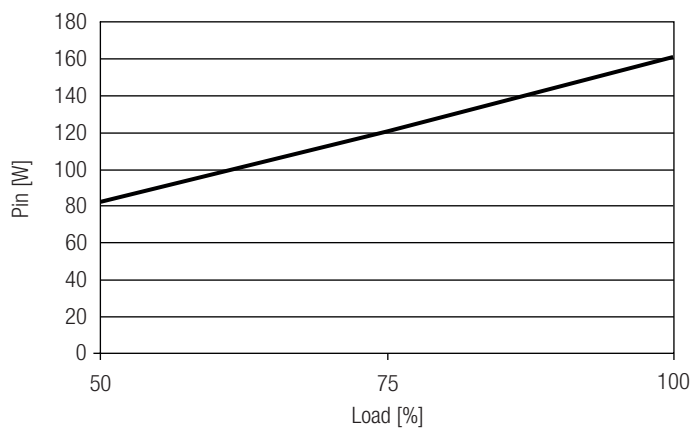

Diagrams LCI 150W 700mA OTD EC

Efficiency vs Load

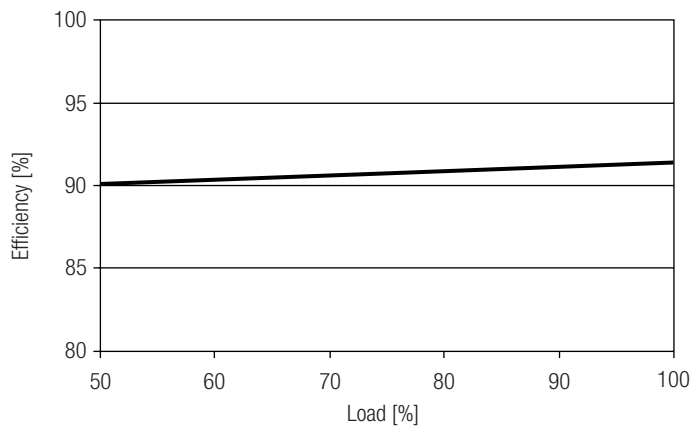

Power factor vs Load

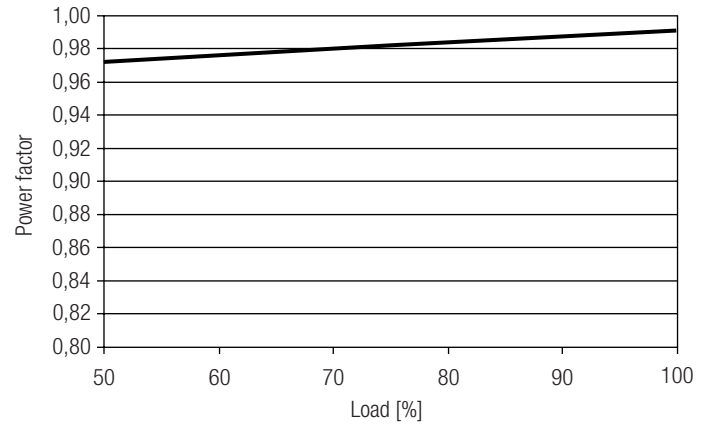

THD vs Load

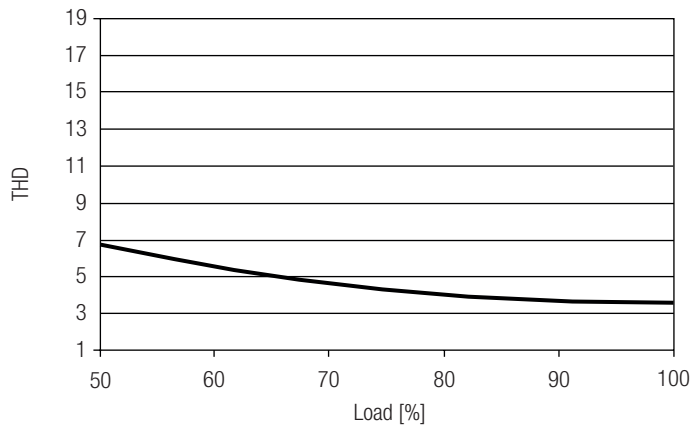

Input current vs load

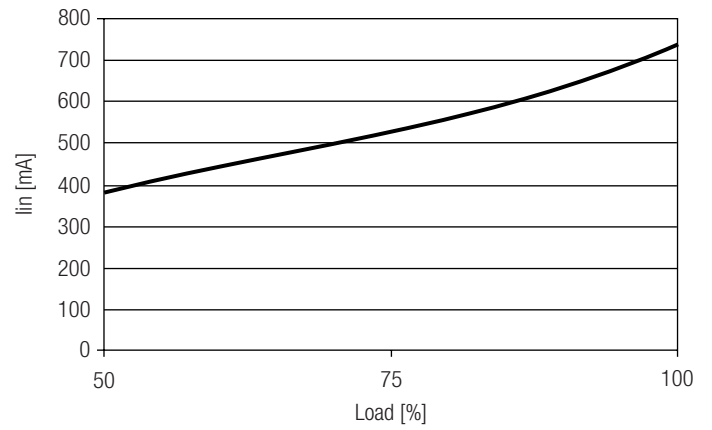

Input power vs load

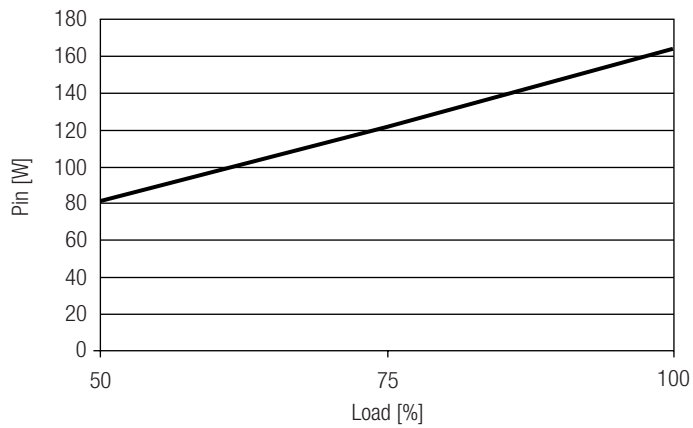

Diagrams LCI 150W 1050mA OTD EC

Efficiency vs Load

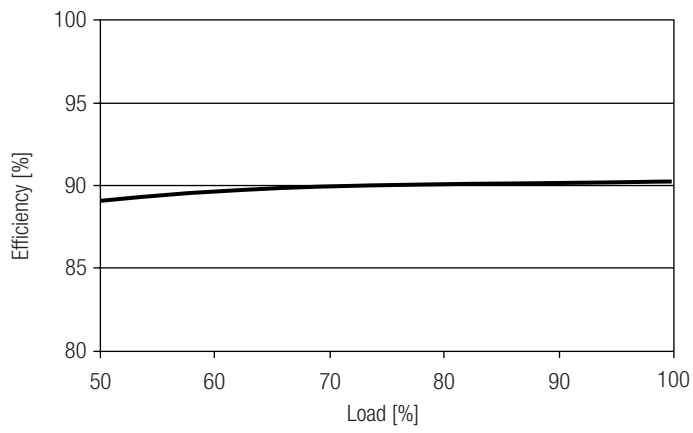

Power factor vs Load

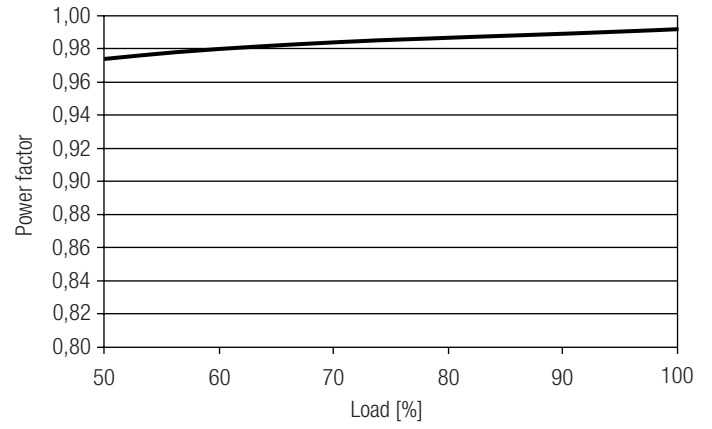

THD vs Load

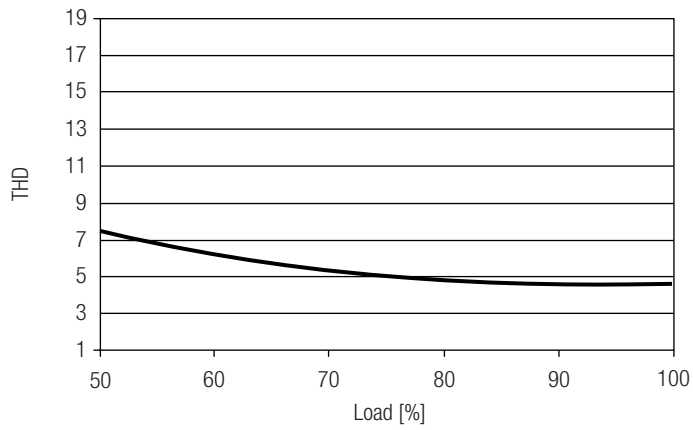

Input current vs load

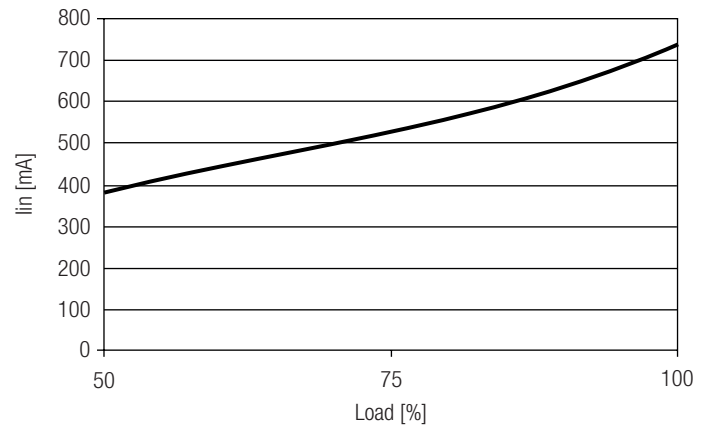

Input power vs load

