



**TALEXmodule LLE G1 24mm ADV-SE**  
TALEXmodule LLE ADVANCED

**Product description**

- Ideal for linear and panel lights
- Optimal solution for linear and panel lights where cost is main priority, together with the new LCI TEC Ip LED Driver provides best system efficiency
- Ideal for T8 refurbishment 650 lm module can be driven to output 800 lm
- 4 pcs. MICROCON SMD connector ( return string with connectors), connectors positioned to allow automatic robot wiring
- Luminous flux range from 490 up to 3,190 lm
- Efficiency of the module up to 147 lm/W
- High colour rendering index CRI > 80
- Small colour tolerance MacAdam 3 (2,700 K MacAdam 4)<sup>®</sup>
- Small luminous flux tolerances
- Colour temperatures 2,700, 3,000, 3,500, 4,000 and 6,500 K
- Perfectly uniform light, even if several LED modules are used together in a line
- Perfect homogenous light with ACL linear diffuse cover
- Push terminals for quick and simple wiring of LED module to LED module
- Simple installation (e.g. ACL push fix)
- Competitive life-time: > 50,000 hours
- 5-year guarantee



**Standards**, page 9

**Colour temperatures and tolerances**, page 13



**TALEXmodule LLE G1 24mm ADV-SE**  
TALEXmodule LLE ADVANCED

**Technical data**

Beam characteristic	120°
Ambient temperature range	-25 ... +45 °C
tp rated	65 °C
tc	85 °C
Max. DC forward current for LLE G1 24x280mm 650lm and LLE G1 24x560mm 1300lm	360 mA
Max. DC forward current for LLE G1 24x280mm 1250lm and LLE G1 24x560mm 2400lm	450 mA
Max. permissible LF current ripple for LLE G1 24x280mm 650lm and LLE G1 24x560mm 1300lm	396 mA
Max. permissible LF current ripple for LLE G1 24x280mm 1250lm and LLE G1 24x560mm 2400lm	495 mA
Max. permissible peak current for LLE G1 24x280mm 650lm and LLE G1 24x560mm 1300lm	480 mA / max. 10 ms
Max. permissible peak current for for LLE G1 24x280mm 1250lm and LLE G1 24x560mm 2400lm	900 mA / max. 10 ms
Max. permissible output voltage of LED Driver <sup>2)</sup>	320 V
Insulation test voltage	1.64 kV
ESD classification	severity level 4
Risk group (EN 62471:2008)	1
Type of protection	IP00

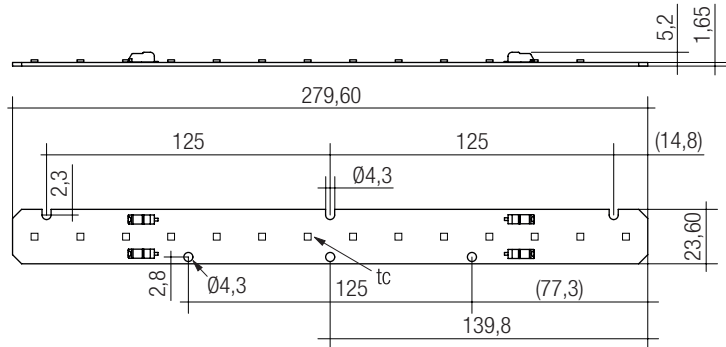

LLE G1 24x280mm 650lm ADV-SE

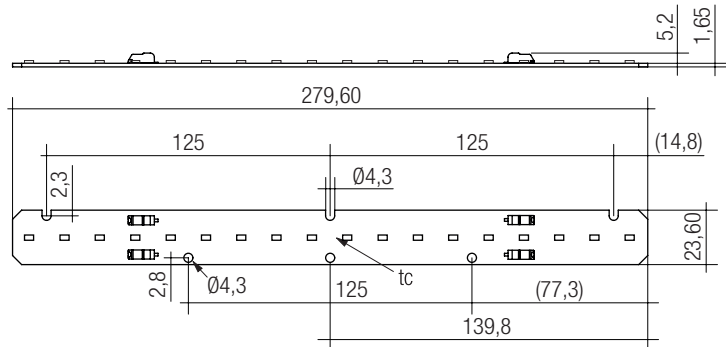

LLE G1 24x280mm 1250lm ADV-SE

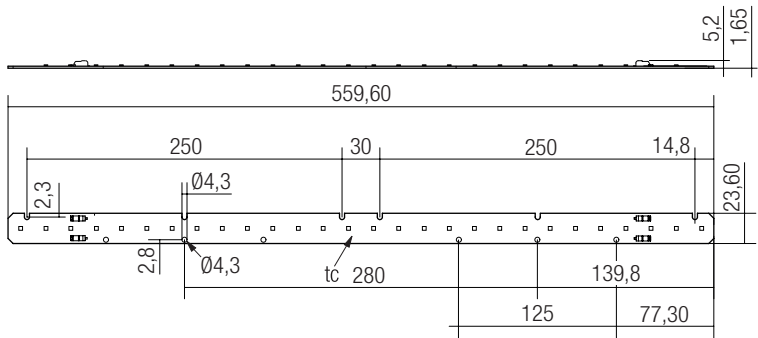

LLE G1 24x560mm 1300lm ADV-SE

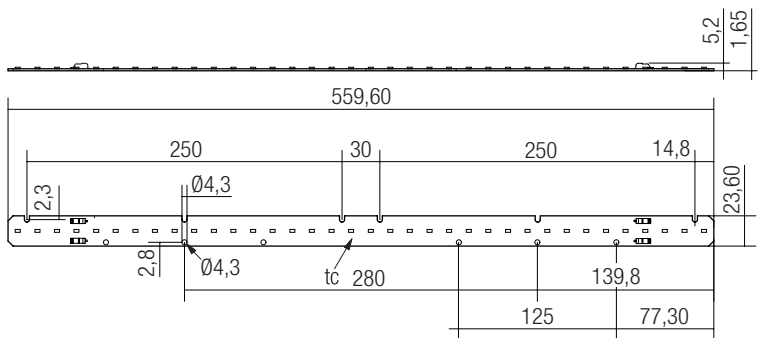

LLE G1 24x560mm 2400lm ADV-SE

## Ordering data

Type	Article number®	Colour temperature	Packaging tray	Weight per pc.
<b>650 lm per 280 mm</b>				
LLE G1 24x280mm 650lm 827 ADV-SE	89600674	2,700 K	30 pc(s).	0.018 kg
LLE G1 24x280mm 650lm 830 ADV-SE	89602128	3,000 K	30 pc(s).	0.018 kg
LLE G1 24x280mm 650lm 835 ADV-SE	89600675	3,500 K	30 pc(s).	0.018 kg
LLE G1 24x280mm 650lm 840 ADV-SE	89602129	4,000 K	30 pc(s).	0.018 kg
LLE G1 24x280mm 650lm 865 ADV-SE	89602130	6,500 K	30 pc(s).	0.018 kg
LLE G1 24x560mm 1300lm 827 ADV-SE	89600856	2,700 K	30 pc(s).	0.042 kg
LLE G1 24x560mm 1300lm 830 ADV-SE	89602134	3,000 K	30 pc(s).	0.042 kg
LLE G1 24x560mm 1300lm 835 ADV-SE	89600857	3,500 K	30 pc(s).	0.042 kg
LLE G1 24x560mm 1300lm 840 ADV-SE	89602135	4,000 K	30 pc(s).	0.042 kg
LLE G1 24x560mm 1300lm 865 ADV-SE	89602136	6,500 K	30 pc(s).	0.042 kg
<b>1250 lm per 280 mm</b>				
LLE G1 24x280mm 1250lm 827 ADV-SE	89600677	2,700 K	30 pc(s).	0.018 kg
LLE G1 24x280mm 1250lm 830 ADV-SE	89602131	3,000 K	30 pc(s).	0.018 kg
LLE G1 24x280mm 1250lm 835 ADV-SE	89600678	3,500 K	30 pc(s).	0.018 kg
LLE G1 24x280mm 1250lm 840 ADV-SE	89602132	4,000 K	30 pc(s).	0.018 kg
LLE G1 24x280mm 1250lm 865 ADV-SE	89602133	6,500 K	30 pc(s).	0.018 kg
LLE G1 24x560mm 2400lm 827 ADV-SE	89600859	2,700 K	30 pc(s).	0.042 kg
LLE G1 24x560mm 2400lm 830 ADV-SE	89602137	3,000 K	30 pc(s).	0.042 kg
LLE G1 24x560mm 2400lm 835 ADV-SE	89600860	3,500 K	30 pc(s).	0.042 kg
LLE G1 24x560mm 2400lm 840 ADV-SE	89602138	4,000 K	30 pc(s).	0.042 kg
LLE G1 24x560mm 2400lm 865 ADV-SE	89602139	6,500 K	30 pc(s).	0.042 kg

## Specific technical data

Type <sup>®</sup>	Photo-metric code	Typ. luminous flux at tp = 25 °C <sup>①</sup>	Typ. luminous flux at tp = 65 °C <sup>①</sup>	Typ. forward current	Min. forward voltage at tp = 65 °C	Max. forward voltage at tp = 25 °C	Typ. power consumption at tp = 65 °C <sup>②</sup>	Efficacy of the module at tp = 25 °C	Efficacy of the module at tp = 65 °C	Efficacy of the system at tp = 65 °C	Colour rendering index CRI
<b>650 lm per 280 mm – Operating mode HE</b>											
LLE G1 24x280mm 650lm 827 ADV-SE	827/449	550 lm	520 lm	200 mA	19.4 V	22.9 V	4.1 W	129 lm/W	125 lm/W	110 lm/W	> 80
LLE G1 24x280mm 650lm 830 ADV-SE	830/349	520 lm	490 lm	200 mA	18.5 V	21.9 V	4.1 W	122 lm/W	118 lm/W	104 lm/W	> 80
LLE G1 24x280mm 650lm 835 ADV-SE	835/349	620 lm	580 lm	200 mA	19.4 V	22.9 V	4.1 W	145 lm/W	141 lm/W	124 lm/W	> 80
LLE G1 24x280mm 650lm 840 ADV-SE	840/349	560 lm	530 lm	200 mA	18.5 V	21.9 V	4.1 W	133 lm/W	129 lm/W	114 lm/W	> 80
LLE G1 24x280mm 650lm 865 ADV-SE	865/349	570 lm	540 lm	200 mA	18.5 V	21.9 V	4.1 W	134 lm/W	131 lm/W	115 lm/W	> 80
LLE G1 24x560mm 1300lm 827 ADV-SE	827/449	1,090 lm	1,040 lm	200 mA	37.1 V	45.3 V	8.3 W	129 lm/W	125 lm/W	110 lm/W	> 80
LLE G1 24x560mm 1300lm 830 ADV-SE	830/349	1,040 lm	980 lm	200 mA	37.1 V	43.9 V	8.3 W	122 lm/W	118 lm/W	104 lm/W	> 80
LLE G1 24x560mm 1300lm 835 ADV-SE	835/349	1,230 lm	1,170 lm	200 mA	37.1 V	45.3 V	8.3 W	145 lm/W	141 lm/W	124 lm/W	> 80
LLE G1 24x560mm 1300lm 840 ADV-SE	840/349	1,130 lm	1,070 lm	200 mA	37.1 V	43.9 V	8.3 W	133 lm/W	129 lm/W	114 lm/W	> 80
LLE G1 24x560mm 1300lm 865 ADV-SE	865/349	1,140 lm	1,090 lm	200 mA	37.1 V	43.9 V	8.3 W	134 lm/W	131 lm/W	115 lm/W	> 80
<b>650 lm per 280 mm – Operating mode BLO</b>											
LLE G1 24x280mm 650lm 827 ADV-SE	827/449	670 lm	640 lm	250 mA	19.7 V	23.2 V	5.3 W	124 lm/W	120 lm/W	108 lm/W	> 80
LLE G1 24x280mm 650lm 830 ADV-SE	830/349	640 lm	600 lm	250 mA	18.7 V	22.2 V	5.3 W	119 lm/W	113 lm/W	100 lm/W	> 80
LLE G1 24x280mm 650lm 835 ADV-SE	835/349	750 lm	720 lm	250 mA	19.7 V	23.2 V	5.3 W	138 lm/W	136 lm/W	122 lm/W	> 80
LLE G1 24x280mm 650lm 840 ADV-SE	840/349	700 lm	660 lm	250 mA	18.7 V	22.2 V	5.3 W	130 lm/W	125 lm/W	110 lm/W	> 80
LLE G1 24x280mm 650lm 865 ADV-SE	865/349	700 lm	670 lm	250 mA	18.7 V	22.2 V	5.3 W	130 lm/W	125 lm/W	110 lm/W	> 80
LLE G1 24x560mm 1300lm 827 ADV-SE	827/449	1,340 lm	1,270 lm	250 mA	39.3 V	46.4 V	10.6 W	123 lm/W	120 lm/W	108 lm/W	> 80
LLE G1 24x560mm 1300lm 830 ADV-SE	830/349	1,280 lm	1,210 lm	250 mA	37.5 V	44.4 V	10.5 W	117 lm/W	115 lm/W	101 lm/W	> 80
LLE G1 24x560mm 1300lm 835 ADV-SE	835/349	1,510 lm	1,430 lm	250 mA	39.3 V	46.4 V	10.6 W	139 lm/W	135 lm/W	122 lm/W	> 80
LLE G1 24x560mm 1300lm 840 ADV-SE	840/349	1,390 lm	1,310 lm	250 mA	37.5 V	44.4 V	10.5 W	128 lm/W	125 lm/W	110 lm/W	> 80
LLE G1 24x560mm 1300lm 865 ADV-SE	865/349	1,400 lm	1,330 lm	250 mA	37.5 V	44.4 V	10.5 W	128 lm/W	127 lm/W	111 lm/W	> 80
<b>650 lm per 280 mm – Operating mode HO</b>											
LLE G1 24x280mm 650lm 827 ADV-SE	827/449	800 lm	760 lm	300 mA	20.1 V	23.7 V	6.5 W	121 lm/W	117 lm/W	105 lm/W	> 80
LLE G1 24x280mm 650lm 830 ADV-SE	830/349	750 lm	710 lm	300 mA	19.1 V	22.6 V	6.5 W	114 lm/W	109 lm/W	96 lm/W	> 80
LLE G1 24x280mm 650lm 835 ADV-SE	835/349	900 lm	850 lm	300 mA	20.1 V	23.7 V	6.5 W	136 lm/W	131 lm/W	118 lm/W	> 80
LLE G1 24x280mm 650lm 840 ADV-SE	840/349	820 lm	780 lm	300 mA	19.1 V	22.6 V	6.5 W	124 lm/W	120 lm/W	106 lm/W	> 80
LLE G1 24x280mm 650lm 865 ADV-SE	865/349	840 lm	790 lm	300 mA	19.1 V	22.6 V	6.5 W	126 lm/W	121 lm/W	107 lm/W	> 80
LLE G1 24x560mm 1300lm 827 ADV-SE	827/449	1,600 lm	1,520 lm	300 mA	40.2 V	47.5 V	13.0 W	120 lm/W	117 lm/W	105 lm/W	> 80
LLE G1 24x560mm 1300lm 830 ADV-SE	830/349	1,500 lm	1,420 lm	300 mA	38.2 V	45.3 V	12.9 W	113 lm/W	110 lm/W	97 lm/W	> 80
LLE G1 24x560mm 1300lm 835 ADV-SE	835/349	1,800 lm	1,710 lm	300 mA	40.2 V	47.5 V	13.0 W	135 lm/W	132 lm/W	119 lm/W	> 80
LLE G1 24x560mm 1300lm 840 ADV-SE	840/349	1,640 lm	1,550 lm	300 mA	38.2 V	45.3 V	12.9 W	123 lm/W	120 lm/W	106 lm/W	> 80
LLE G1 24x560mm 1300lm 865 ADV-SE	865/349	1,650 lm	1,560 lm	300 mA	38.2 V	45.3 V	12.9 W	124 lm/W	121 lm/W	106 lm/W	> 80

<sup>①</sup> Tolerance range for optical and electrical data: ±10 %.

<sup>②</sup> If mounted with M4 screws and plastic washers.

<sup>③</sup> Integral measurement over the complete module.

<sup>④</sup> HE ... high efficiency, BLO ... best LED operation, HO ... high output.

<sup>⑤</sup> 89600675, 89600857, 89600678 and 89600860 purchase to order.

## Specific technical data

Type <sup>®</sup>	Photo-metric code	Typ. luminous flux at tp = 25 °C <sup>①</sup>	Typ. luminous flux at tp = 65 °C <sup>①</sup>	Typ. forward current	Min. forward voltage at tp = 65 °C	Max. forward voltage at tp = 25 °C	Typ. power consumption at tp = 65 °C <sup>②</sup>	Efficacy of the module at tp = 25 °C	Efficacy of the module at tp = 65 °C	Efficacy of the system at tp = 65 °C	Colour rendering index CRI
<b>1250 lm per 280 mm – Operating mode HE</b>											
LLE G1 24x280mm 1250lm 827 ADV-SE	827/449	1,110 lm	1,070 lm	225 mA	31.9 V	37.8 V	7.9 W	136 lm/W	134 lm/W	118 lm/W	> 80
LLE G1 24x280mm 1250lm 830 ADV-SE	830/349	1,090 lm	1,030 lm	225 mA	33.8 V	37.8 V	7.9 W	133 lm/W	130 lm/W	114 lm/W	> 80
LLE G1 24x280mm 1250lm 835 ADV-SE	835/349	1,220 lm	1,170 lm	225 mA	31.9 V	37.8 V	7.9 W	149 lm/W	147 lm/W	129 lm/W	> 80
LLE G1 24x280mm 1250lm 840 ADV-SE	840/349	1,180 lm	1,120 lm	225 mA	33.8 V	37.8 V	7.9 W	145 lm/W	141 lm/W	124 lm/W	> 80
LLE G1 24x280mm 1250lm 865 ADV-SE	865/349	1,180 lm	1,120 lm	225 mA	33.8 V	37.8 V	7.9 W	145 lm/W	141 lm/W	124 lm/W	> 80
LLE G1 24x560mm 2400lm 827 ADV-SE	827/449	2,230 lm	2,130 lm	225 mA	63.8 V	75.6 V	15.9 W	136 lm/W	134 lm/W	118 lm/W	> 80
LLE G1 24x560mm 2400lm 830 ADV-SE	830/349	2,170 lm	2,060 lm	225 mA	67.6 V	75.6 V	15.9 W	133 lm/W	130 lm/W	114 lm/W	> 80
LLE G1 24x560mm 2400lm 835 ADV-SE	835/349	2,440 lm	2,330 lm	225 mA	63.8 V	75.6 V	15.9 W	149 lm/W	147 lm/W	129 lm/W	> 80
LLE G1 24x560mm 2400lm 840 ADV-SE	840/349	2,360 lm	2,240 lm	225 mA	67.6 V	75.6 V	15.9 W	145 lm/W	141 lm/W	124 lm/W	> 80
LLE G1 24x560mm 2400lm 865 ADV-SE	865/349	2,360 lm	2,240 lm	225 mA	67.6 V	75.6 V	15.9 W	145 lm/W	141 lm/W	124 lm/W	> 80
<b>1250 lm per 280 mm – Operating mode BLO</b>											
LLE G1 24x280mm 1250lm 827 ADV-SE	827/449	1,230 lm	1,180 lm	250 mA	32.2 V	36.7 V	8.7 W	134 lm/W	132 lm/W	120 lm/W	> 80
LLE G1 24x280mm 1250lm 830 ADV-SE	830/349	1,200 lm	1,130 lm	250 mA	34.3 V	38.3 V	8.9 W	130 lm/W	127 lm/W	112 lm/W	> 80
LLE G1 24x280mm 1250lm 835 ADV-SE	835/349	1,350 lm	1,290 lm	250 mA	32.2 V	36.7 V	8.7 W	146 lm/W	145 lm/W	131 lm/W	> 80
LLE G1 24x280mm 1250lm 840 ADV-SE	840/349	1,300 lm	1,240 lm	250 mA	34.3 V	38.3 V	8.9 W	141 lm/W	138 lm/W	121 lm/W	> 80
LLE G1 24x280mm 1250lm 865 ADV-SE	865/349	1,300 lm	1,240 lm	250 mA	34.3 V	38.3 V	8.9 W	141 lm/W	138 lm/W	121 lm/W	> 80
LLE G1 24x560mm 2400lm 827 ADV-SE	827/449	2,460 lm	2,360 lm	250 mA	64.4 V	73.4 V	17.4 W	134 lm/W	132 lm/W	120 lm/W	> 80
LLE G1 24x560mm 2400lm 830 ADV-SE	830/349	2,390 lm	2,270 lm	250 mA	68.5 V	76.6 V	17.8 W	130 lm/W	127 lm/W	112 lm/W	> 80
LLE G1 24x560mm 2400lm 835 ADV-SE	835/349	2,700 lm	2,580 lm	250 mA	64.4 V	73.4 V	17.4 W	147 lm/W	144 lm/W	130 lm/W	> 80
LLE G1 24x560mm 2400lm 840 ADV-SE	840/349	2,610 lm	2,470 lm	250 mA	68.5 V	76.6 V	17.8 W	142 lm/W	139 lm/W	122 lm/W	> 80
LLE G1 24x560mm 2400lm 865 ADV-SE	865/349	2,610 lm	2,470 lm	250 mA	68.5 V	76.6 V	17.8 W	142 lm/W	139 lm/W	122 lm/W	> 80
<b>1250 lm per 280 mm – Operating mode HO</b>											
LLE G1 24x280mm 1250lm 827 ADV-SE	827/449	1,460 lm	1,390 lm	300 mA	32.7 V	37.2 V	10.6 W	129 lm/W	127 lm/W	117 lm/W	> 80
LLE G1 24x280mm 1250lm 830 ADV-SE	830/349	1,480 lm	1,340 lm	300 mA	35.1 V	39.7 V	10.9 W	125 lm/W	122 lm/W	107 lm/W	> 80
LLE G1 24x280mm 1250lm 835 ADV-SE	835/349	1,560 lm	1,530 lm	300 mA	32.7 V	37.2 V	10.6 W	141 lm/W	139 lm/W	125 lm/W	> 80
LLE G1 24x280mm 1250lm 840 ADV-SE	840/349	1,540 lm	1,460 lm	300 mA	35.1 V	39.7 V	10.9 W	136 lm/W	134 lm/W	118 lm/W	> 80
LLE G1 24x280mm 1250lm 865 ADV-SE	865/349	1,540 lm	1,460 lm	300 mA	35.1 V	39.7 V	10.9 W	136 lm/W	134 lm/W	118 lm/W	> 80
LLE G1 24x560mm 2400lm 827 ADV-SE	827/449	2,910 lm	2,780 lm	300 mA	65.3 V	74.4 V	21.3 W	129 lm/W	126 lm/W	116 lm/W	> 80
LLE G1 24x560mm 2400lm 830 ADV-SE	830/349	2,820 lm	2,680 lm	300 mA	70.2 V	78.5 V	22.0 W	125 lm/W	122 lm/W	107 lm/W	> 80
LLE G1 24x560mm 2400lm 835 ADV-SE	835/349	3,190 lm	3,050 lm	300 mA	65.3 V	74.4 V	21.3 W	141 lm/W	138 lm/W	124 lm/W	> 80
LLE G1 24x560mm 2400lm 840 ADV-SE	840/349	3,080 lm	2,920 lm	300 mA	70.2 V	78.5 V	22.0 W	136 lm/W	133 lm/W	117 lm/W	> 80
LLE G1 24x560mm 2400lm 865 ADV-SE	865/349	3,080 lm	2,920 lm	300 mA	70.2 V	78.5 V	22.0 W	136 lm/W	133 lm/W	117 lm/W	> 80

<sup>①</sup> Tolerance range for optical and electrical data: ±10 %.

<sup>②</sup> If mounted with M4 screws and plastic washers.

<sup>③</sup> Integral measurement over the complete module.

<sup>④</sup> HE ... high efficiency, BLO ... best LED operation, HO ... high output.

<sup>⑤</sup> 89600675, 89600857, 89600678 and 89600860 purchase to order.

**Product description**

- LINEAR COVER for LLE 24
- Protection against direct touch for non-SELV applications
- Fast snap on mounting on to LLE 24 with clips or plastic washers
- High transmission: transparent 94 %, semi-transparent 87 %, diffuse 76 %
- Made of PMMA
- Tolerances:  $\pm 1$  mm for 597 mm length (ends finished),  
+ 20 mm for 1,200 / 1,500 / 1,600 / 1,800 mm length (ends raw)

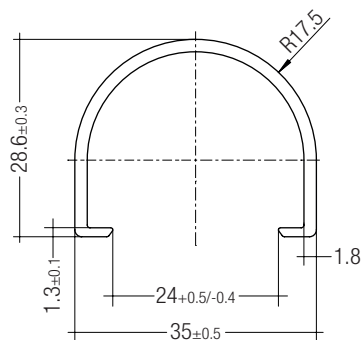
**Ordering data**

Type	Article number	Colour	Length	Packaging carton	Weight per pc.
LINEAR COVER SY Transparent 1600mm	28000338	Transparent	1,600 mm	12 pc(s).	0.272 kg
LINEAR COVER SY Frosted 1800mm	28000437	Semi-transparent	1,800 mm	12 pc(s).	0.308 kg
LINEAR COVER SY Frosted 1600mm	28000339	Semi-transparent	1,600 mm	12 pc(s).	0.272 kg
LINEAR COVER SY Frosted 1500mm	28000435	Semi-transparent	1,500 mm	12 pc(s).	0.244 kg
LINEAR COVER SY Frosted 1200mm	28000422	Semi-transparent	1,200 mm	12 pc(s).	0.205 kg
LINEAR COVER SY Frosted 597mm	28000340	Semi-transparent	597 mm	12 pc(s).	0.102 kg
LINEAR COVER SY Diffuse 1800mm	28000438	Diffuse	1,800 mm	12 pc(s).	0.308 kg
LINEAR COVER SY Diffuse 1600mm	28000341	Diffuse	1,600 mm	12 pc(s).	0.272 kg
LINEAR COVER SY Diffuse 1500mm	28000436	Diffuse	1,500 mm	12 pc(s).	0.257 kg
LINEAR COVER SY Diffuse 1200mm	28000434	Diffuse	1,200 mm	12 pc(s).	0.205 kg
LINEAR COVER SY Diffuse 597mm	28000342	Diffuse	597 mm	12 pc(s).	0.102 kg

## ACL ENDCAP LLE24 PUSH-FIX

## Product description

- ENDCAP for LLE 24
- Fast snap on mounting (sheet thickness 0.5 – 1.0 mm), for drilling hole 4 mm
- Made of Polycarbonat

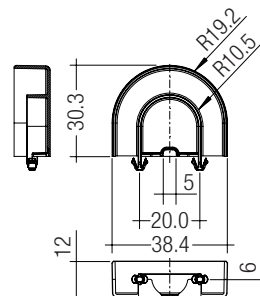

## Ordering data

Type	Article number	Colour	Packaging carton	Weight per pc.
ACL ENDCAP LLE24 PUSH-FIX	28001037	White	480 pc(s).	0.003 kg

## LINEAR LENS

## Product description

- Linear lens for LLE 24
- Available in 60° and 90° light distribution
- Protection against direct touch for non-SELV applications
- Fast snap on mounting on to LLE 24 with clips or plastic washers
- High transmission: semi-transparent 97 %
- Linear lense made of PMMA
- Tolerances:  $\pm 20$  mm for 1,600 mm legth (ends raw)

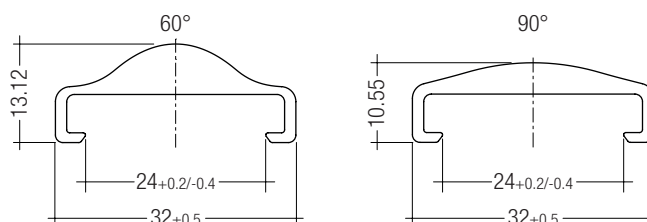

## Ordering data

Type	Article number	Colour	Length	Packaging carton	Weight per pc.
ACL LINEAR LENS 24x1200mm 60°	28001428	semi-transparent	1,200 mm	21 pc(s).	0.196 kg
ACL LINEAR LENS 24x1200mm 90°	28001429	semi-transparent	1,200 mm	21 pc(s).	0.165 kg
ACL LINEAR LENS 24x1600mm 60°	28000953	semi-transparent	1,600 mm	21 pc(s).	0.261 kg
ACL LINEAR LENS 24x1600mm 90°	28000955	semi-transparent	1,600 mm	21 pc(s).	0.221 kg

ACCES-  
SORIES

## CLIP 4.3mm

## Product description

- Clip for fixation of LED modules with 4.3 mm holes
- Fast snap on mounting (sheet thickness 0.5 – 1.0 mm)
- For drilling hole 4 mm
- Clip made of Polycarbonat

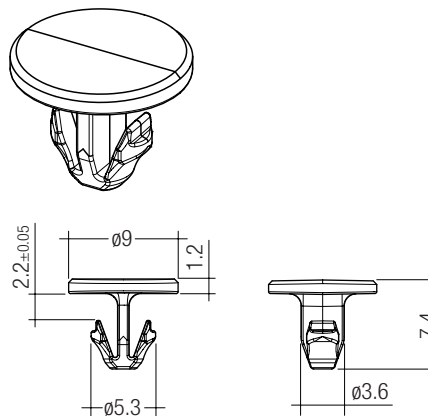

## Ordering data

Type	Article number	Colour	Packaging bag <sup>①</sup>	Weight per pc.
ACL CLIP 4.3mm PUSH-FIX	28001036	White	500 pc(s).	0.001 kg

<sup>①</sup> Minimum sales quantity 500 pcs.

ACCES-  
SORIES

## BRIDGE LLE24/40

## Product description

- Enables the fixation of 24 mm wide Tridonic LED modules to fixtures made for 40 mm wide modules
- Ideal for extruded aluminium gear trays made for 40 mm modules with pre-alignment knobs
- Clip-on for LINEAR COVER and LINEAR LENS<sup>②</sup>
- For LLE 24 with 280 mm module minimum 2 bridges required
- For LLE 24 with 560 mm module minimum 3 bridges required
- Fixation via M3 or M4 countersunk screw, max. tightening torque 0.5 Nm
- BRIDGE made of white polycarbonate

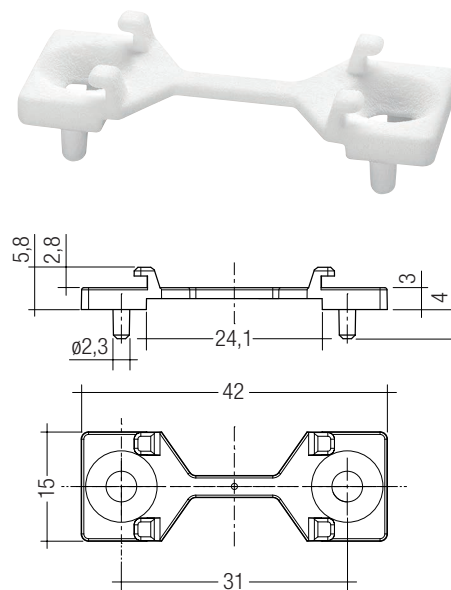

## Ordering data

Type	Article number	Colour	Packaging carton <sup>①</sup>	Weight per pc.
ACL BRIDGE LLE24/40 SCREW-FIX	28001205	White	600 Stk.	0.001 kg

<sup>①</sup> Minimum sales quantity 600 pcs.

<sup>②</sup> Beam characteristics will change due to the elevated fixation (see photometric files for details).



## 1. Standards

IEC 62031  
IEC 62471  
IEC 62717  
IEC 61000-4-2

### 1.1 Photometric code

Key for photometric code, e. g. 830 / 349

1 <sup>st</sup> digit	2 <sup>nd</sup> + 3 <sup>rd</sup> digit	4 <sup>th</sup> digit	5 <sup>th</sup> digit	6 <sup>th</sup> digit	
Code	CRI	Colour temperature in Kelvin x 100	McAdam after 25% of the life-time (max.6000h)	Luminous flux after 25% of the life-time (max.6000h)	
				Code	Luminous flux
7	70 – 79			7	≥ 70 %
8	80 – 89			8	≥ 80 %
9	≥90			9	≥ 90 %

### 1.2 Energy classification

Type	Forward current	Energy classification
LLE 24x280mm 650lm 827 ADV-SE	200 mA	A++
	250 mA	A++
	300 mA	A+
LLE 24x280mm 650lm 830 ADV-SE	200 mA	A+
	250 mA	A+
	300 mA	A+
LLE 24x280mm 650lm 835 ADV-SE	200 mA	A++
	250 mA	A++
	300 mA	A++
LLE 24x280mm 650lm 840 ADV-SE	200 mA	A+
	250 mA	A+
	300 mA	A+
LLE 24x280mm 650lm 865 ADV-SE	200 mA	A+
	250 mA	A+
	300 mA	A+
LLE 24x560mm 1300lm 827 ADV-SE	200 mA	A+
	250 mA	A+
	300 mA	A+
LLE 24x560mm 1300lm 830 ADV-SE	200 mA	A+
	250 mA	A+
	300 mA	A+
LLE 24x560mm 1300lm 835 ADV-SE	200 mA	A++
	250 mA	A+
	300 mA	A+
LLE 24x560mm 1300lm 840 ADV-SE	200 mA	A+
	250 mA	A+
	300 mA	A+
LLE 24x560mm 1300lm 865 ADV-SE	200 mA	A+
	250 mA	A+
	300 mA	A+
LLE 24x280mm 1250lm 827 ADV-SE	225 mA	A++
	250 mA	A++
	300 mA	A+
LLE 24x280mm 1250lm 830 ADV-SE	225 mA	A+
	250 mA	A+
	300 mA	A+
LLE 24x280mm 1250lm 835 ADV-SE	225 mA	A++
	250 mA	A++
	300 mA	A++
LLE 24x280mm 1250lm 840 ADV-SE	225 mA	A++
	250 mA	A++
	300 mA	A+
LLE 24x280mm 1250lm 865 ADV-SE	225 mA	A++
	250 mA	A++
	300 mA	A+
LLE 24x560mm 2400lm 827 ADV-SE	225 mA	A+
	250 mA	A+
	300 mA	A+
LLE 24x560mm 2400lm 830 ADV-SE	225 mA	A+
	250 mA	A+
	300 mA	A+
LLE 24x560mm 2400lm 835 ADV-SE	225 mA	A++
	250 mA	A++
	300 mA	A++
LLE 24x560mm 2400lm 840 ADV-SE	225 mA	A++
	250 mA	A++
	300 mA	A+
LLE 24x560mm 2400lm 865 ADV-SE	225 mA	A++
	250 mA	A++
	300 mA	A+

## 2. Thermal details

### 2.1 tc point, ambient temperature and life-time

The temperature at tp reference point is crucial for the light output and life-time of a TALEX product.

For TALEXmodule LLE a tp temperature of 65 °C has to be complied in order to achieve an optimum between heat sink requirements, light output and life-time.

Compliance with the maximum permissible reference temperature at the tc point must be checked under operating conditions in a thermally stable state. The maximum value must be determined under worst-case conditions for the relevant application.

The tc and tp temperature of LED modules from Tridonic are measured at the same reference point.

### 2.2 Storage and humidity

Storage temperature	-30 ... +90 °C
---------------------	----------------

Operation only in non condensing environment.

Humidity during processing of the module should be between 30 to 70 %.

### 2.3 Thermal design and heat sink

The rated life of TALEX products depends to a large extent on the temperature. If the permissible temperature limits are exceeded, the life of the TALEXmodule LLE will be greatly reduced or the TALEXmodule LLE may be destroyed.

### 2.4 Heat sink values

TALEXmodule LLE G1 24x280mm 650lm 8xx ADV-SE

ta	tp	Forward current	R <sub>th, hs-a</sub>	Cooling area
25 °C	65 °C	250 mA	10.89 K/W	61 cm <sup>2</sup>
35 °C	65 °C	250 mA	8.17 K/W	82 cm <sup>2</sup>
45 °C	65 °C	250 mA	5.44 K/W	122 cm <sup>2</sup>
25 °C	65 °C	300 mA	8.65 K/W	77 cm <sup>2</sup>
35 °C	65 °C	300 mA	8.17 K/W	82 cm <sup>2</sup>
45 °C	65 °C	300 mA	5.44 K/W	122 cm <sup>2</sup>

TALEXmodule LLE G1 24x560mm 1300lm 8xx ADV-SE

ta	tp	Forward current	R <sub>th, hs-a</sub>	Cooling area
25 °C	65 °C	250 mA	5.44 K/W	123 cm <sup>2</sup>
35 °C	65 °C	250 mA	4.08 K/W	163 cm <sup>2</sup>
45 °C	65 °C	250 mA	2.72 K/W	245 cm <sup>2</sup>
25 °C	65 °C	300 mA	4.32 K/W	154 cm <sup>2</sup>
35 °C	65 °C	300 mA	4.08 K/W	163 cm <sup>2</sup>
45 °C	65 °C	300 mA	2.72 K/W	245 cm <sup>2</sup>

TALEXmodule LLE G1 24x280mm 1250lm 8xx ADV-SE

ta	tp	Forward current	R <sub>th, hs-a</sub>	Cooling area
25 °C	65 °C	250 mA	8.13 K/W	82 cm <sup>2</sup>
35 °C	65 °C	250 mA	6.10 K/W	109 cm <sup>2</sup>
45 °C	65 °C	250 mA	4.06 K/W	164 cm <sup>2</sup>
25 °C	65 °C	300 mA	6.45 K/W	103 cm <sup>2</sup>
35 °C	65 °C	300 mA	4.83 K/W	138 cm <sup>2</sup>
45 °C	65 °C	300 mA	3.22 K/W	207 cm <sup>2</sup>

TALEXmodule LLE G1 24x560mm 2400lm 8xx ADV-SE

ta	tp	Forward current	R <sub>th, hs-a</sub>	Cooling area
25 °C	65 °C	250 mA	4.06 K/W	164 cm <sup>2</sup>
35 °C	65 °C	250 mA	3.05 K/W	218 cm <sup>2</sup>
45 °C	65 °C	250 mA	2.03 K/W	328 cm <sup>2</sup>
25 °C	65 °C	300 mA	3.24 K/W	206 cm <sup>2</sup>
35 °C	65 °C	300 mA	2.43 K/W	275 cm <sup>2</sup>
45 °C	65 °C	300 mA	1.62 K/W	412 cm <sup>2</sup>

#### Notes

The actual cooling surface can differ because of the material, the structural shape, outside influences and the installation situation. Depending on the heat sink a heat conducting paste or heat conducting film might be necessary to keep the specified tp temperature.

### 3. Installation / wiring

#### 3.1 Electrical supply/choice of LED Driver

TALEXmodule LLE from Tridonic are not protected against overvoltages, overcurrents, overloads or short-circuit currents. Safe and reliable operation can only be guaranteed in conjunction with a LED Driver which complies with the relevant standards. The use of TALEXconverter from Tridonic in combination with TALEXmodule LLE guarantees the necessary protection for safe and reliable operation.

If a LED Driver other than Tridonic TALEXconverter is used, it must provide the following protection:

- Short-circuit protection
- Overload protection
- Overtemperature protection



TALEXmodule LLE must be supplied by a constant current LED Driver. Operation with a constant voltage LED Driver will lead to an irreversible damage of the module.

Wrong polarity can damage the TALEXmodule LLE.

If TALEXmodules LLE are wired in parallel and a wire breaks or a complete module fails then the current passing through the other module increases. This may reduce its life considerably. In addition there can be slight differences in light output caused by tolerances.

TALEXmodule LLE can be operated either from SELV LED Drivers or from LED Drivers with LV output voltage.



TALEXmodule LLE are basic isolated up to 320 V against ground and can be mounted directly on earthed metal parts of the luminaire. If the max. output voltage of the LED Driver (also against earth) is above 320 V, an additional isolation between LED module and heat sink is required (for example by isolated thermal pads) or by a suitable luminaire construction. At voltages > 60 V an additional protection against direct touch (test finger) to the light emitting side of the module has to be guaranteed. This is typically achieved by means of a non removable light distributor over the module.

#### 3.2 Wiring

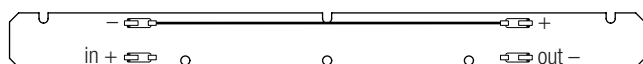

#### Wiring examples

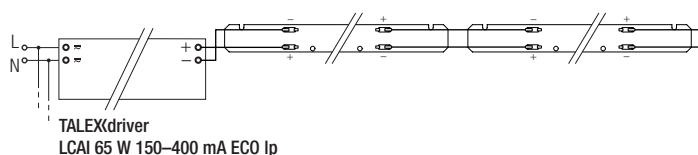

#### 3.3 Wiring type and cross section

The wiring can be in stranded wires with ferrules or solid with a cross section of 0.2 to 0.75 mm<sup>2</sup>.

For the push-wire connection you have to strip the insulation (8–9 mm).

wire preparation:  
0.2 – 0.75 mm<sup>2</sup>

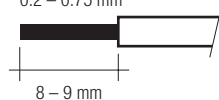

To remove the wires use a suitable tool (e.g. Microcon release pin) or through twist and pull.

#### 3.4 Mounting instruction



None of the components of the TALEXmodule LLE (substrate, LED, electronic components etc.) may be exposed to tensile or compressive stresses.

Max. torque for fixing: 0.5 Nm.

The LED modules are mounted onto a heat sink with min. 5 screws per module. In order not to damage the modules only rounded head screws and an additional plastic flat washer should be used.



Chemical substance may harm the LED module. Chemical reactions could lead to colour shift, reduced luminous flux or a total failure of the module caused by corrosion of electrical connections.

Materials which are used in LED applications (e.g. sealings, adhesives) must not produce dissolver gas. They must not be condensation curing based, acetate curing based or contain sulfur, chlorine or phthalate. Avoid corrosive atmosphere during usage and storage.

#### 3.5 EOS/ESD safety guidelines



The device / module contains components that are sensitive to electrostatic discharge and may only be installed in the factory and on site if appropriate EOS/ESD protection measures have been taken. No special measures need be taken for devices/modules with enclosed casings (contact with the pc board not possible), just normal installation practice. Please note the requirements set out in the document EOS / ESD guidelines (Guideline\_EOS\_ESD.pdf) at: <http://www.tridonic.com/esd-protection>

### 4. Life-time

#### 4.1 Life-time, lumen maintenance and failure rate

The light output of an LED Module decreases over the life-time, this is characterized with the L value.

L70 means that the LED module will give 70 % of its initial luminous flux. This value is always related to the number of operation hours and therefore defines the life-time of an LED module.

As the L value is a statistical value and the lumen maintenance may vary over the delivered LED modules.

The B value defines the amount of modules which are below the specific L value, e.g. L70B10 means 10 % of the LED modules are below 70 % of the initial luminous flux, respectively 90 % will be above 70 % of the initial value. In addition the percentage of failed modules (fatal failure) is characterized by the C value.

The F value is the combination of the B and C value. That means for F degradation and complete failures are considered, e.g. L70F10 means 10 % of the LED modules may fail or be below 70 % of the initial luminous flux.

Life-time declarations are informative and represent no warranty claim.

## 4.2 Lumen maintenance

Life-time declarations are informative and represent no warranty claim.

TALEX(module LLE 24x280mm 650lm und LLE 24x560mm 1300lm

Forward current	tp temperature	L90 / F10	L90 / F50	L80 / F10	L80 / F50	L70 / F10	L70 / F50
250 mA	55 °C	>50,000 h	>50,000 h	>50,000 h	>50,000 h	>50,000 h	>50,000 h
	65 °C	26,000 h	>50,000 h	>50,000 h	>50,000 h	>50,000 h	>50,000 h
	75 °C	14,000 h	32,000 h	27,000 h	>50,000 h	42,000 h	>50,000 h
300 mA	55 °C	49,000 h	>50,000 h	>50,000 h	>50,000 h	>50,000 h	>50,000 h
	65 °C	25,000 h	>50,000 h	>50,000 h	>50,000 h	>50,000 h	>50,000 h
	75 °C	13,000 h	31,000 h	25,000 h	>50,000 h	40,000 h	>50,000 h

TALEX(module LLE 24x280mm 1250lm und LLE 24x560mm 2400lm

Forward current	tp temperature	L90 / F10	L90 / F50	L80 / F10	L80 / F50	L70 / F10	L70 / F50
250 mA	55 °C	>50,000 h	>50,000 h	>50,000 h	>50,000 h	>50,000 h	>50,000 h
	65 °C	28,000 h	>50,000 h	>50,000 h	>50,000 h	>50,000 h	>50,000 h
	75 °C	15,000 h	35,000 h	29,000 h	>50,000 h	44,000 h	>50,000 h
300 mA	55 °C	>50,000 h	>50,000 h	>50,000 h	>50,000 h	>50,000 h	>50,000 h
	65 °C	27,000 h	>50,000 h	>50,000 h	>50,000 h	>50,000 h	>50,000 h
	75 °C	13,500 h	31,000 h	27,500 h	>50,000 h	42,000 h	>50,000 h

## 5. Electrical values

### 5.1 Typ. forward voltage vs. forward current

LLE G1 24x280mm 650lm

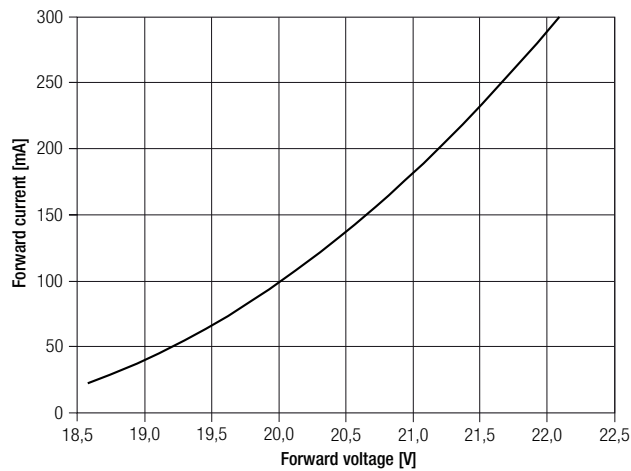

LLE G1 24x560mm 1300lm

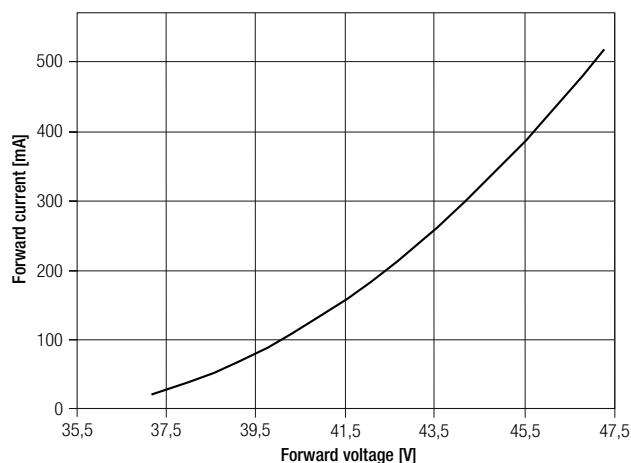

LLE G1 24x280mm 1250lm

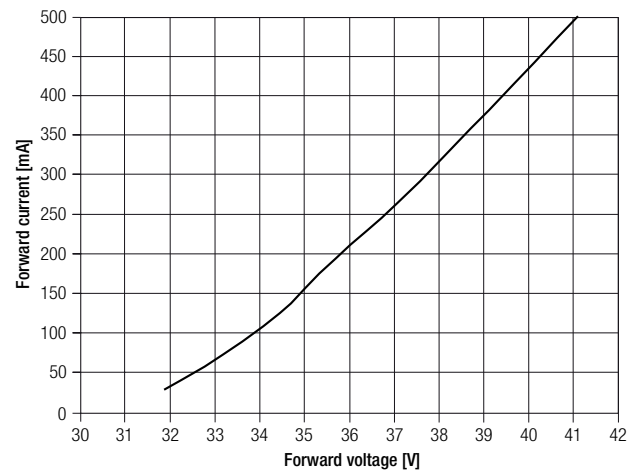

LLE G1 24x560mm 2400lm

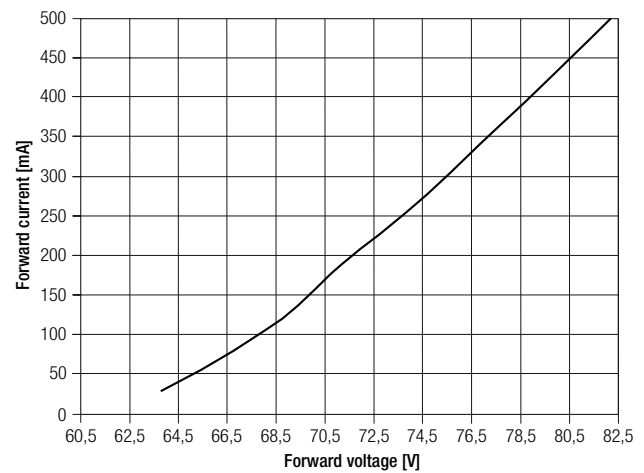

### 5.2 Forward voltage vs. tc temperature

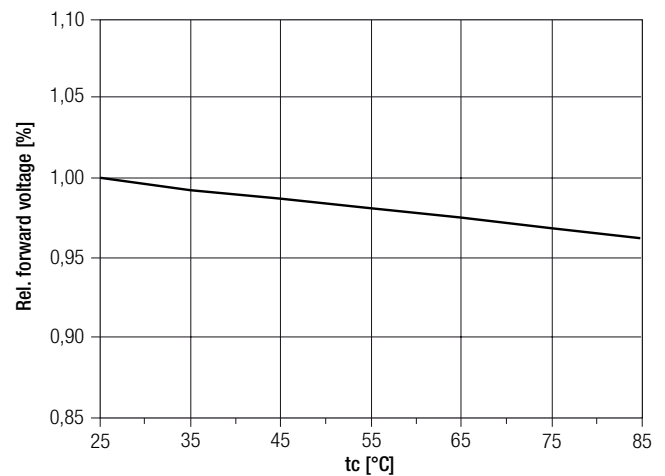

The diagrams are based on statistic values.  
The real values can be different.

## 6. Photometric characteristics

### 6.1 Coordinates and tolerances according to CIE 1931

The specified colour coordinates are integral measured by a current impulse of 250 mA and a duration of 100 ms.

The ambient temperature of the measurement is  $t_a = 25\text{ °C}$ .

The measurement tolerance of the colour coordinates are  $\pm 0.01$ .

#### 2,700 K

	x0	y0
Center	0.4585	0.4104

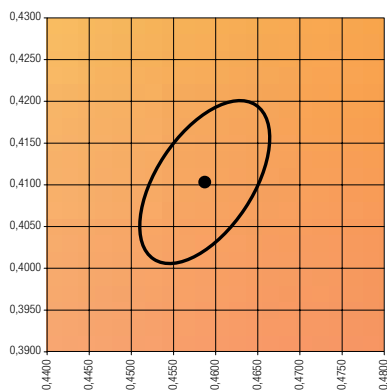

— MacAdam Ellipse: 4SDCM

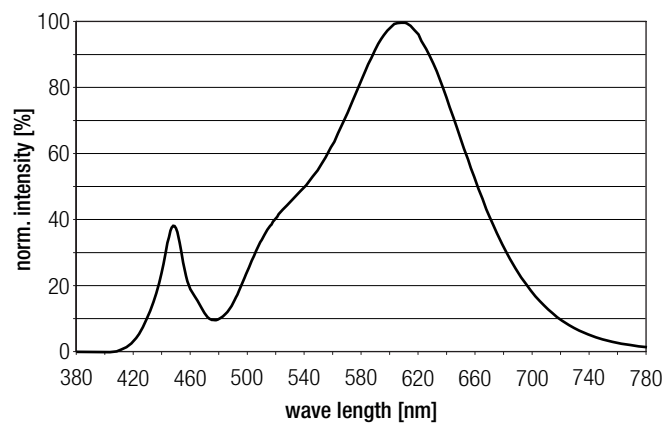

#### 3,000 K

	x0	y0
Center	0.4344	0.4032

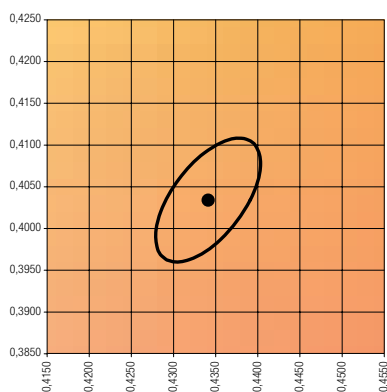

— MacAdam Ellipse: 3SDCM

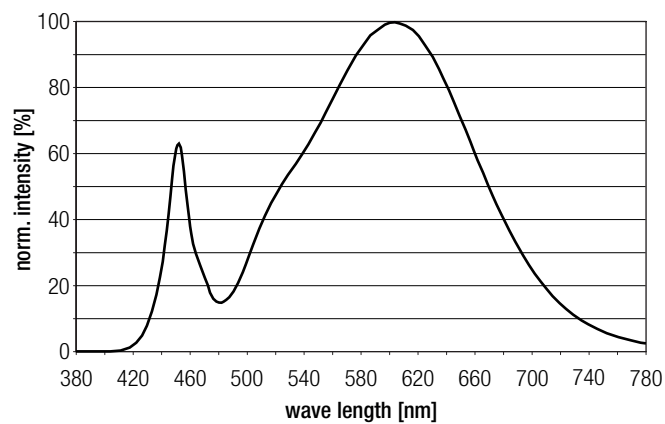

#### 3,500 K

	x0	y0
Center	0.4085	0.3928

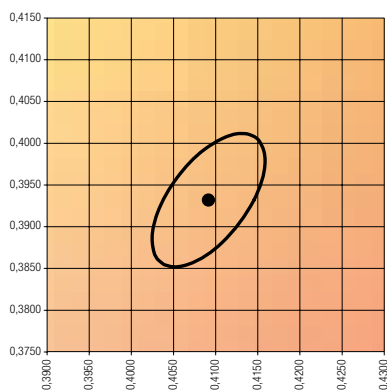

— MacAdam Ellipse: 3SDCM

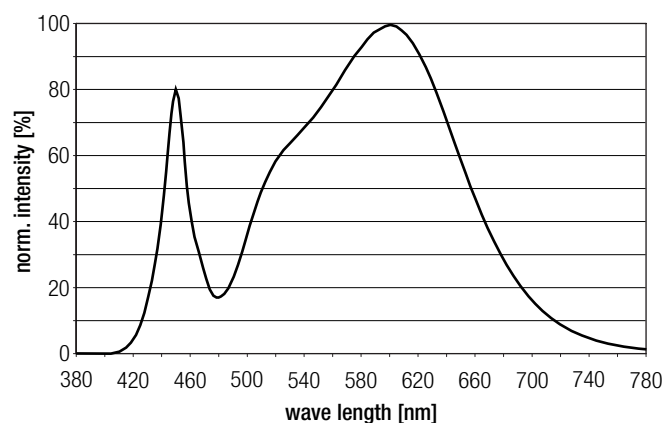

4,000 K

	x0	y0
Center	0.3825	0.3796

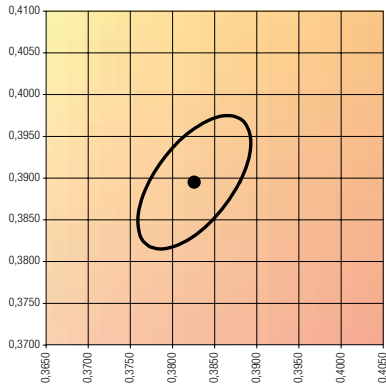

— MacAdam Ellipse: 3SDCM

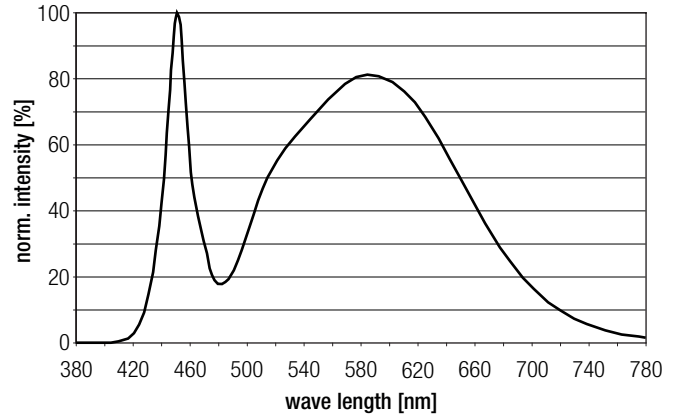

6,500 K

	x0	y0
Center	0.3135	0.3284

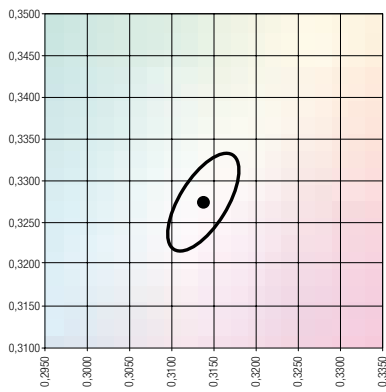

— MacAdam Ellipse: 3SDCM

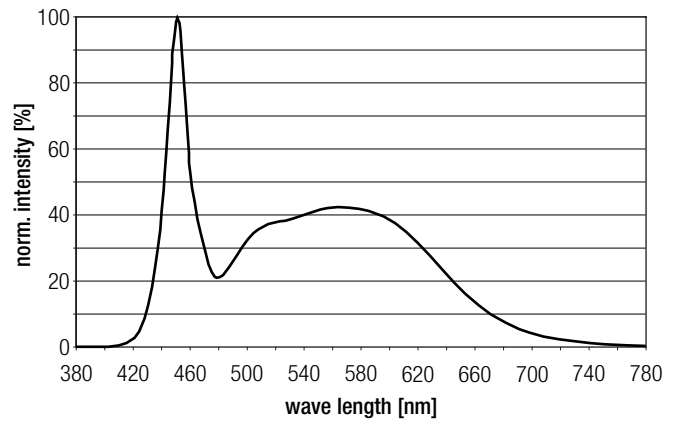

### 6.2 Light distribution

The optical design of the TALEX module LLE product line ensures optimum homogeneity for the light distribution.

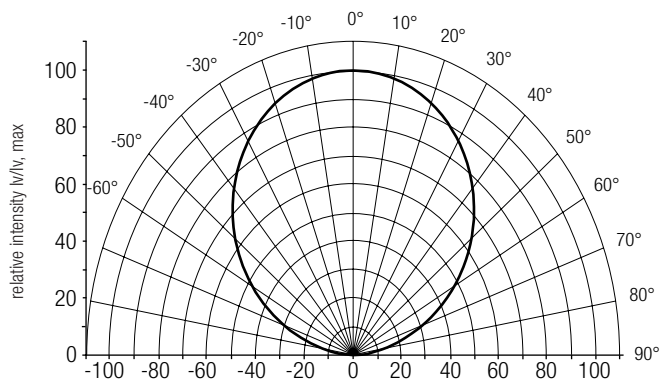

The colour temperature is measured integral over the complete module. The single LED light points can have deviations in the colour coordinates within MacAdam 7. To ensure an ideal mixture of colours and a homogenous light distribution a suitable optic (e. g. PMMA diffuser) and a sufficient spacing between module and optic (typ. 4 cm) should be used.

For further information see Design-in Guide, 3D data and photometric data on [www.tridonic.com](http://www.tridonic.com) or on request.

### 6.3 Relative luminous flux vs. tc temperature

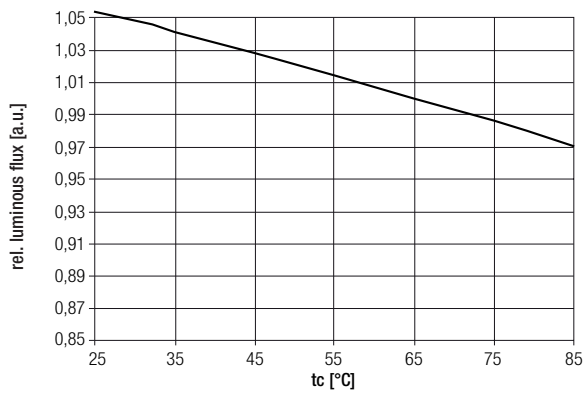

### 6.4 Relative luminous flux vs. operating current

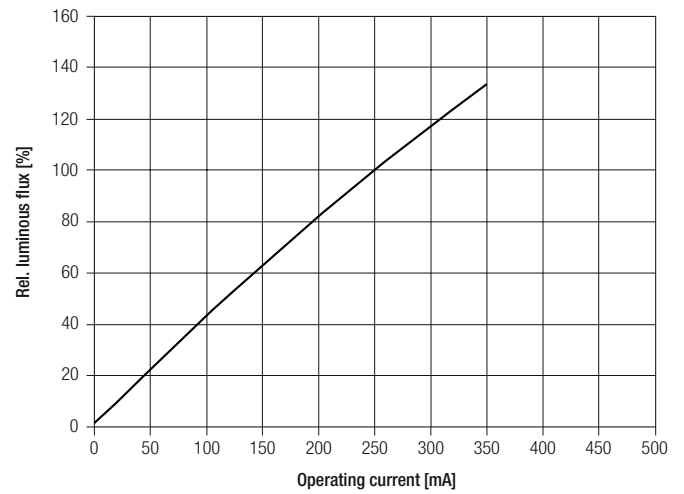

The diagrams are based on statistic values. The real values can be different.